

September 2016

CAN Newsletter

Hardware + Software + Tools + Engineering

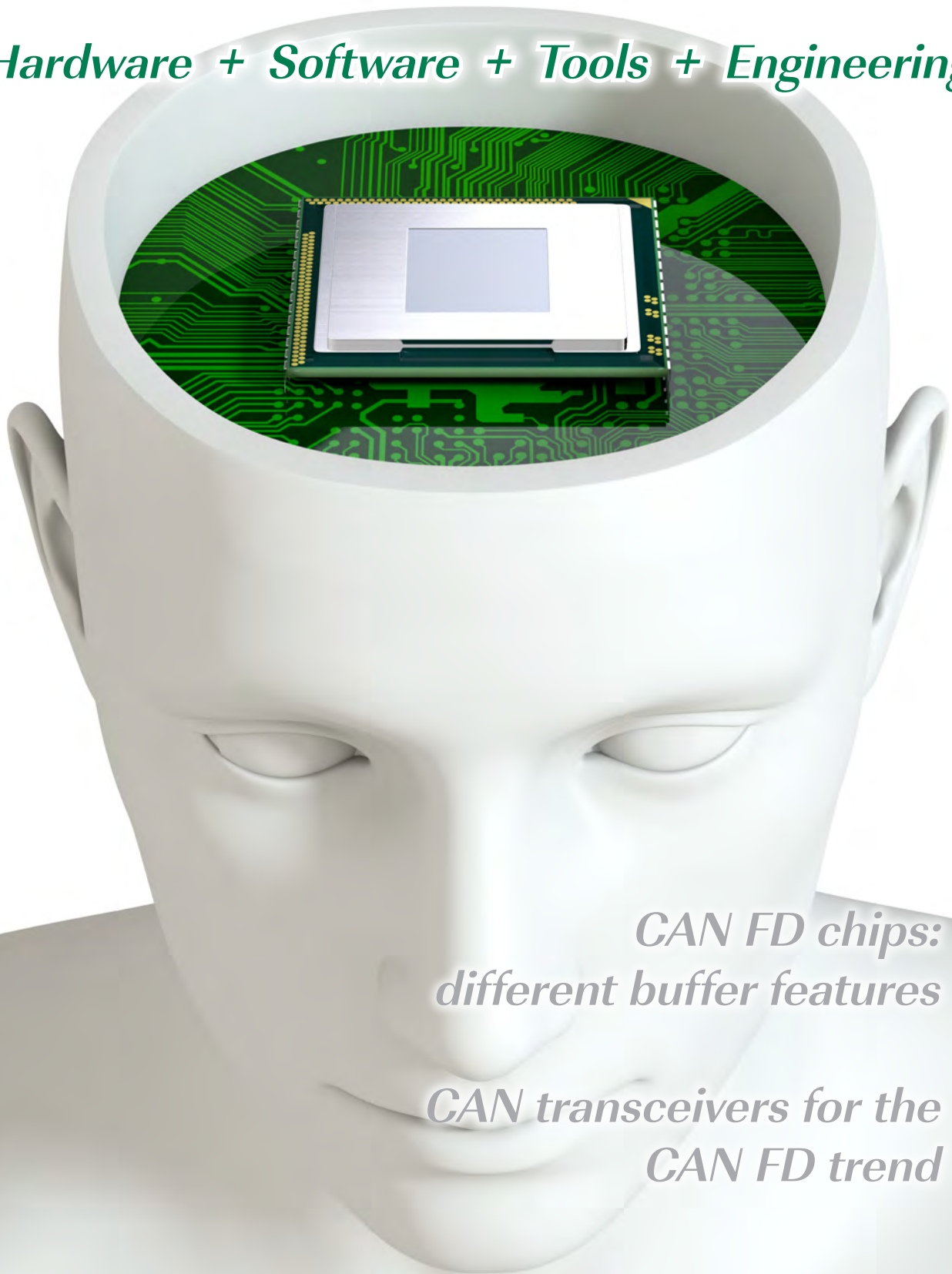

*CAN FD chips:
different buffer features*

*CAN transceivers for the
CAN FD trend*

Semiconductors

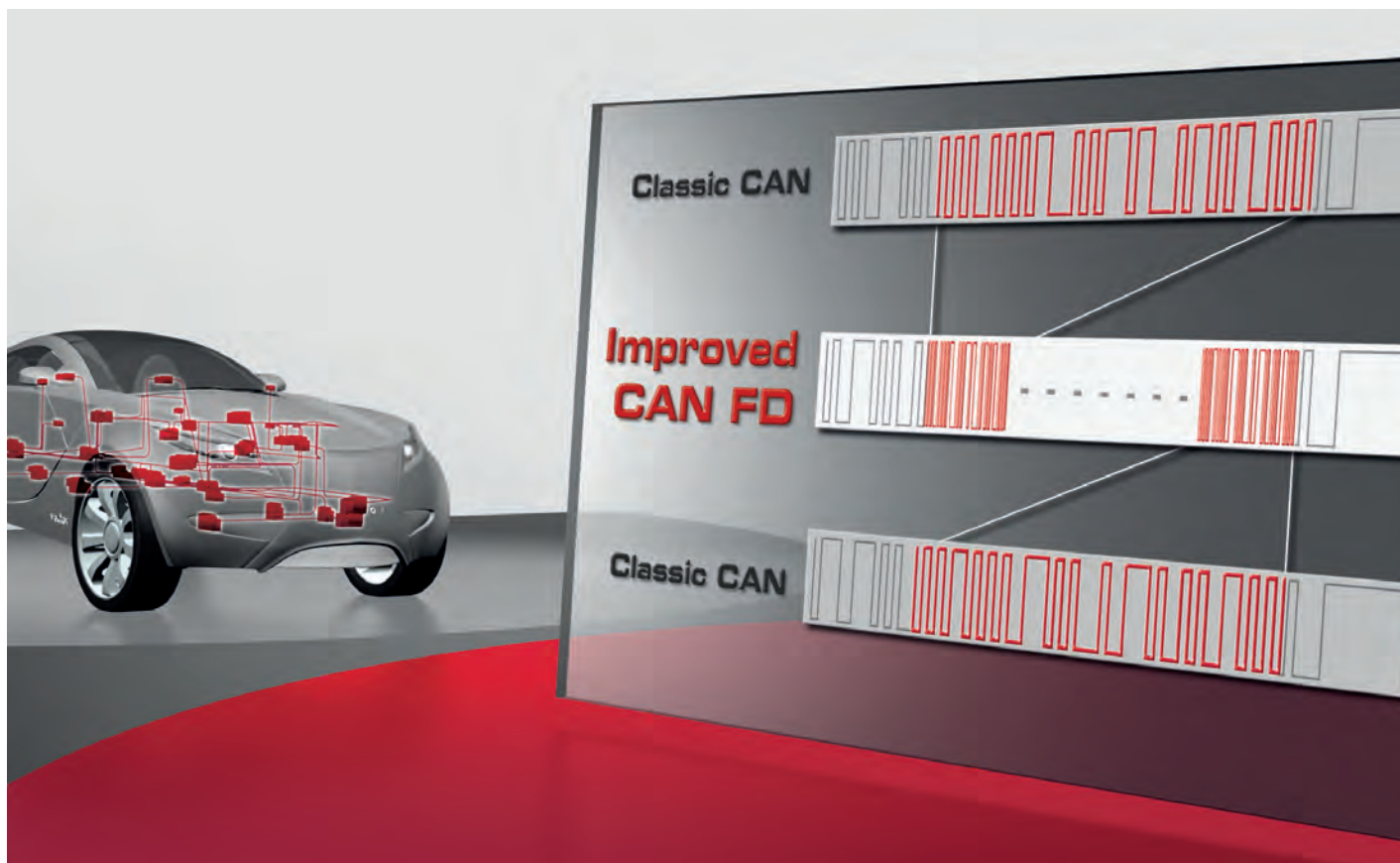

First class solutions for your CAN and CAN FD based projects

Complete and universal tool chain

Increase the efficiency of your projects with the use of the complete tool chain from Vector:

- > Tools for testing, flashing and calibrating ECUs
- > Flexible bus network interfaces
- > High performance Scope for bit accurate signal analysis
- > Easy to configure AUTOSAR basic software
- > Worldwide engineering services and trainings

Information and downloads: www.can-solutions.com

More CAN power: benefit from over 25 years of networking experience.

CAN/CAN FD Poster
now order for free:
www.vector.com/canfd_poster



Semiconductors

CAN FD chips: different buffer features	4
CAN transceivers for the CAN FD trend	32

Imprint

Publisher

CAN in Automation GmbH
Kontumazgarten 3
DE-90429 Nuremberg

publications@can-cia.org
www.can-cia.org

Tel.: +49-911-928819-0
Fax: +49-911-928819-79

CEO Holger Zeltwanger
AG Nürnberg 24338

Downloads June issue:
(retrieved August 24, 2016)
11 000 full magazine

Editors

pr@can-cia.org

Annegret Emerich
Cindy Weissmueller
Holger Zeltwanger
(responsible according
to the press law)

Layout

Nickel Plankermann

Media consultants

Gisela Scheib
(responsible according
to the press law)
Meng Xie-Buchert

Distribution manager

Meng Xie-Buchert

© Copyright

CAN in Automation GmbH



CANopen

Enriching the Internet with CANopen	12
Good to know: The CANopen vendor-ID is mandatory	14
Position sensors can CANopen	22



Engineering

Linking Ethernet and CAN	8
CAN is taking over light vehicles	20
From developer's tool to HIL test system	28



Safety

CANopen for functional safe drives	16
On the safe side with IEC 61508	26
Extra safety, comfort, and efficiency	38

CAN 2020 events – The future of CAN

CAN in Automation has scheduled [several CAN 2020 events](#) focusing on CAN FD, CANopen FD, J1939 on CAN FD, and other CAN-related future developments. Part of the seminar is the introduction of CiA 602-2 specifying the mapping of J1939-PGNs to CAN FD frames. The participation for members is free-of-charge. [Registration](#) is possible on the CiA website.

CAN FD chips: different buffer features

Several IP core vendors have announced CAN FD products. Some of these CAN FD cores are already implemented in micro-controllers. They differ especially regarding the message buffer capabilities and other dedicated features.

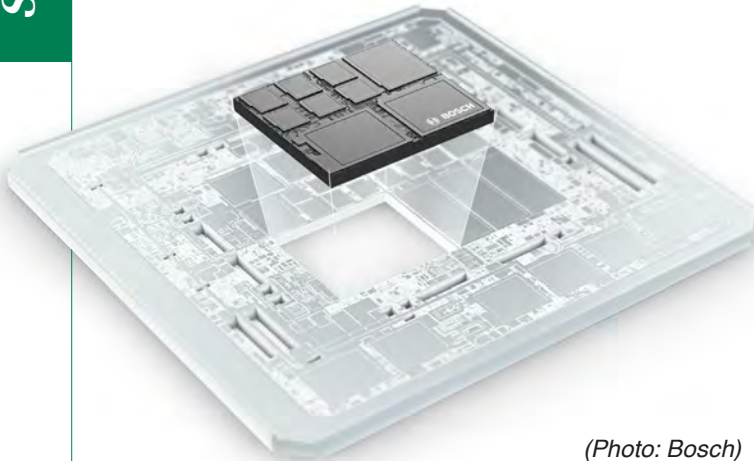

(Photo: Bosch)

The ISO 11898-1:2015 standard specifies the CAN FD protocol. All implementations have to follow this standard to conform to ISO CAN FD. Conformity testing will be standardized in ISO 16845-1:2016. On the TXD and RXD lines, all controllers behave alike. Of course, some optional features are not supported by all implementations. Also, some older implementations are not consistent with the ISO standard. The CAN community has agreed to term these non-ISO CAN FD.

The first implementation, the M_CAN module by Bosch, has been updated to be compliant to ISO 11898-1:2015. Several micro-controller manufacturers have adapted it, e.g. Cypress (formerly Spansion), Infineon, NXP (including the recently acquired Freescale), Renesas, STMicroelectronics, Texas Instruments, and Toshiba. Unfortunately, nobody – including Bosch – offers the M_CAN module as a stand-alone CAN FD controller yet.

M_CAN: The “grandmother” of implementations

Bosch's M_CAN module has passed several improvement steps. Originally, it implemented the original CAN FD protocol (non-ISO CAN FD). Today, the IP core supports both the ISO CAN FD and the non-ISO CAN FD protocols. Theoretically, it can be realized as a stand-alone device, as part of an ASIC, or as an FPGA. Of course, it can also be integrated in a micro-controller. The CAN module is described in VHDL on RTL level, and is prepared for synthesis. It needs two clock domains: CAN and host clock, which are synchronized internally. Due to the synchronization mechanism between the two clock domains, there may be a delay until the value written to INIT can be read back. Therefore, the programmer has to assure that the previous value written to INIT has been accepted by reading INIT before setting INIT to a new value.

According to Bosch, the message storage is intended to be a single- or dual-ported RAM outside of the module. It is connected to the M_CAN via the generic master interface. Depending on the chosen integration, multiple CAN controllers can share the same message memory. The external Rx and Tx message memories can be organized as buffer or FIFO. If the data field size of an accepted CAN frame exceeds the configured size for the matching Rx buffer or Rx FIFO, only the configured number of bytes is stored. The rest of the frame's data field is ignored. If the data length code of a Tx memory element is configured to a value higher than the Tx data field size, the undefined bytes are transmitted as CC₁₆ (padding bytes). Like most implementations, the M_CAN does not check for erroneous configurations of the message memory. Especially the configuration of the start addresses of the different sections and the number of elements of each section has to be done carefully to avoid falsification or loss of data.

The Rx and the Tx handler implement all functions concerning the management of messages. The Rx handler is responsible for the message acceptance filtering, the transfer of received messages from the CAN core to the message memory, and provides receive message status information. The Tx handler manages the transmission of messages and provides transmit status information. Acceptance filtering is implemented by a combination of up to 128 filter elements, each of which can be configured as a range, as a bit-mask, or as a dedicated ID-filter.

The M_CAN module is delivered with a 32-bit CPU interface. For FPGAs, an exemplary interface converter is provided (e.g. to an Avalon interface). It can be replaced by a user-defined module interface. The module provides interrupt control functionality and 16-bit CAN bit time counters for receive and transmit timestamp generation. An externally generated 16-bit vector may substitute the integrated counter. The M_CAN requires about 31 000 gates and about 17 KiB of RAM for message buffering. Additional logic for the host controller interface and message arbitration is needed. The M_CAN is also available for Altera and Xilinx FPGA.

According to Bosch, more than ten market-leading chipmakers have licensed an M_CAN IP module for ASIC and more companies use the IP core in FPGAs. These and other companies, amongst others from the tool and software area, have licensed the CAN FD protocol. Bosch expects about 60 parties to be CAN FD licensees by the end of this year. By the way, the original patents of the Classical CAN protocol ran out in May 2016. This means that everyone ▶

can now implement the Classical CAN protocol royalty free, but implementation patents might still exist. The CAN FD protocol is still patent-protected. Implementers need a license from Bosch.

Other CAN FD cores

Besides Bosch, several companies provide CAN FD cores: Fraunhofer/Cast, IFI, Inicore, Kvaser, and Peak. The CAN controller offered by Cast has already undergone a second round of real-world-like testing at the CAN FD plugfest run by CAN in Automation. Sourced from Fraunhofer IPMS, the CAN-CTRL CAN/CAN FD controller core is one of the ASIC RTL and FPGA netlist IP cores to support all current and proposed specifications (CAN, ISO and non-ISO CAN FD, and TTCAN).

Kvaser's CAN FD IP core also passed the bit-rate tests at the second CAN FD plugfest. The company has developed a complete set of IP blocks for CAN FD, primarily for integration into its own FPGAs. By partnering with Synective Labs, Kvaser's IP modules will be made available for FPGA and ASICs for any non-strategic customers. The CAN FD implementation complies with both ISO and non-ISO CAN FD. Often such IP cores are implemented in FPGAs with additional circuitry to be used in interface boards for PC-based and other tools including data recorders. In general, these IP cores are very flexible regarding the acceptance filtering and message buffering functions.

Interestingly, NXP cooperates with Silvaco to offer the FlexCAN core to other chipmakers. Silvaco recently entered the semiconductor IP market with the acquisition of IPextreme. "The FlexCAN core builds upon our successful relationship with NXP and is an important addition to our large portfolio of proven technology created as a result of this partnership", said Warren Savage, General Manager of the IP Division at Silvaco, "The market demand for faster CAN technology is expanding quickly. The availability of our FlexCAN core allows customers to share the benefits from NXP's years of experience in the automotive semiconductor sector, meeting the stringent requirements necessary for success in this market."

Other CAN FD implementations

Several chipmakers, for example Freescale, Infineon, and Renesas have started to develop their own CAN FD controllers integrated in micro-controllers. They provide dedicated functions regarding message buffering and gateway functionality. The hardware filtering for messages uses the acceptance-filtering list (AFL) with up to 384 entries. Each entry is a reception rule (which set of) messages to accept, which HRH handle of Autosar shall be assigned, which minimum length of accepted messages is required, and where to store these accepted messages. Received CAN FD frames can be filtered based on IDs (11-bit and 29-bit) and DLC value.

Wir leben Elektronik!
We live electronics!

Sontheim 

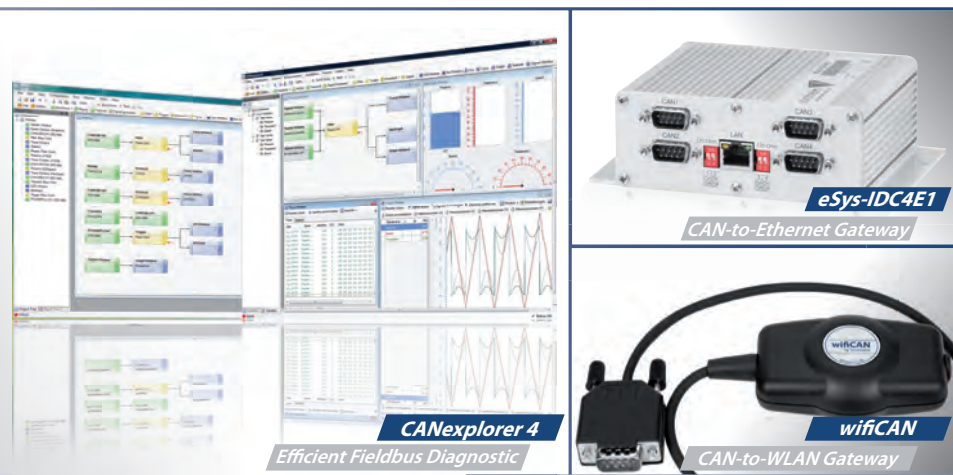

- ▶ Mobile or stationary CAN Interfaces in various form factors with WLAN, Ethernet, USB and more
- ▶ Robust and flexible CAN Gateways and Data Logger with up to 256GB of built-in NAND-Flash-Memory
- ▶ Rugged ECUs for controlling, telemetry services and diagnostic application
- ▶ Monitoring and analyzing - our modular software tools for efficient fieldbus diagnostics
- ▶ Searching for a modular diagnostic tool based on standards?

<http://www.s-i-e.de/en/products/diagnostics/mdt>

Start to Get Free - More Flexibility With Our High-Performant CAN Solutions

As your reliable partner for innovative CAN systems we support you with our tools in all phases of your projects, from design over implementation to testing.

Sontheim Overview and Portfolio:

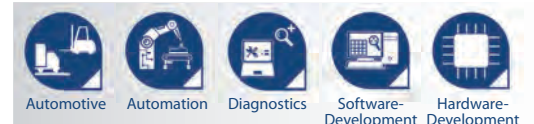

We live electronics!
www.sontheim-industrie-elektronik.de

DE Sontheim Industrie Elektronik GmbH
Georg-Krug-Str. 2, 87437 Kempten
Tel: +49 831 57 59 00-0 - Fax: -73
info@s-i-e.de

US Sontheim Industrial Electronics Inc.
One West Court Square, Suite 750
Decatur, GA 30030
Phone: +1 (404) 494-7839 - Fax: -7701

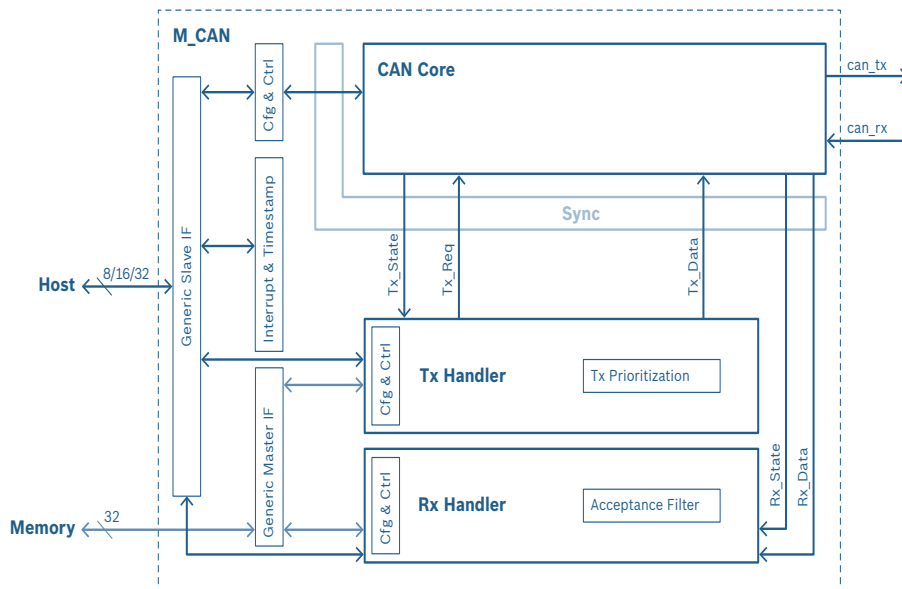

Figure 1: The M_CAN module has been updated to comply with ISO 11898-1:2015 (Photo: Bosch)

Microchip has not yet disclosed details on its CAN FD implementation, which is based on Kvaser's IP core. The chipmaker plans a CAN FD stand-alone controller and micro-controllers with on-chip CAN FD modules. By the end of this year, samples should be available. The prototypes of the stand-alone controller has participated successfully in the CAN FD plugfests organized by CiA.

The Taiwanese chipmaker Holtek plans to release the HT45B3305 CAN stand-alone controller based on the M_CAN in October 2016. ST Microelectronics uses the Bosch M_CAN module at the moment, but doesn't rule out an in-house development in the future.

The transmission of messages depends on the priority or the buffer number. Each message can be disabled individually. The transmit history list with 16 entries per channel is organized as FIFO. This list records the successfully transmitted messages optionally with Autosar references (HTH or soft-ID). For multi-purpose FIFO units, transmission interval timers are available. There is no delay when the FIFO is enabled. The interval between messages continues even if the FIFO becomes temporarily empty during the delay time. Transmission stops and resets the delay when the FIFO is empty.

The RS-CAN FD implementation by Renesas is scalable from one to six CAN FD modules. Multiple module implementations provide dedicated routing functions. This includes a message routing; signal routing is not supported. The AFL filters the received messages from any channel. In gateway mode, one AFL storage target is a multi-purpose FIFO, which is bound to a channel in TX direction. The assigned channel of the this FIFO transmits the received messages via one of its message buffers. These CAN FD modules are already used in the RH850/F1K micro-controller family by Renesas. Key feature is – according to Roland Lieder from Renesas – the flexible usage of the receive memory by all on-chip CAN FD modules. In the current version, this is based on FIFO hardware without priorities. In the next version, prioritized queues will be supported. They will provide a significantly larger message buffer size.

Additional features and modes

Time stamping of messages is a requirement of several OEMs. CiA is working on the CiA 603 specification standardizing the frame time stamping for the network time management. This is independent of the employed CAN protocol (Classical CAN or CAN FD). Nevertheless, CAN FD implementations need to support this function. Current implementations do not provide this time stamping functionality because it is not yet specified in all details. M_CAN customers who are not planning to provide an own implementation hope that Bosch will implement the CiA 603 time stamping in future versions. The CiA Interest Group (IG) CAN FD intends to release the specification at the end of this year. The RS-CAN FD module supports time capturing at SOF sample-point and FDF-res edge and in the future it will also support EOF time-stamping (32 bit) as specified in CiA 603.

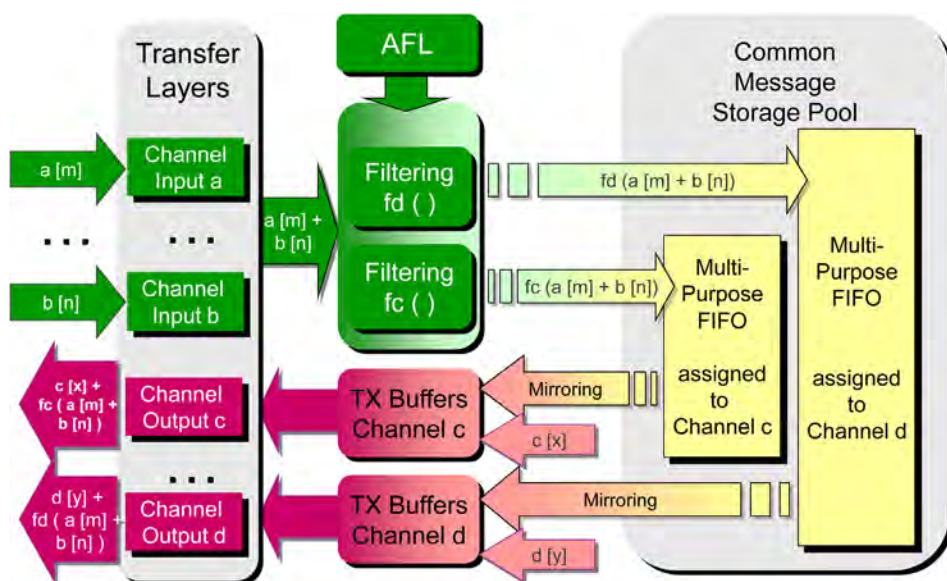

Figure 2: Example with 2-channel output for routing without diagnosis (Photo: Renesas)

Most of the available CAN FD implementations support additional modes. Besides the normal operation mode as specified in ISO 11898:2015, nearly all CAN FD controllers provide a listen-only mode and a low-power (sleep) mode. Other special-purpose modes include a non-automatic re-transmission mode (single-shot transmission), a test mode, as well as external and internal loop-back mode. The external loop-back mode (M_CAN) is intended for hardware self-testing. In the internal loop-back mode, the M_CAN is not connected to the bus, so that the self-test has no effect on other nodes connected to the network.

Summary and outlook

CAN FD implementations differ in their add-on functionality. Selecting one is not that easy; you need to look at the requirements of the application. The host controller interface is not highly standardized. In CiA 601-2, some recommendations and guidelines are given. Software engineers have to design the low-level driver programs properly, in order to avoid lost messages and other unwanted behavior. For the automotive market, Autosar support is an important issue.

In the next month, we will see CAN FD interfaces increasingly implemented in micro-controllers. The majority will be based on M_CAN. Off-the-shelf, stand-alone CAN FD controllers were just pre-announced by Microchip. Like in the past, increasingly ASIC and FPGA solutions will be developed for special-purpose applications. For them, the user has the choice of enough CAN FD cores offered by different companies. ◀

Authors



Annegret Emerich
Holger Zeltwanger
CAN Newsletter
pr@can-cia.org
www.can-cia.org

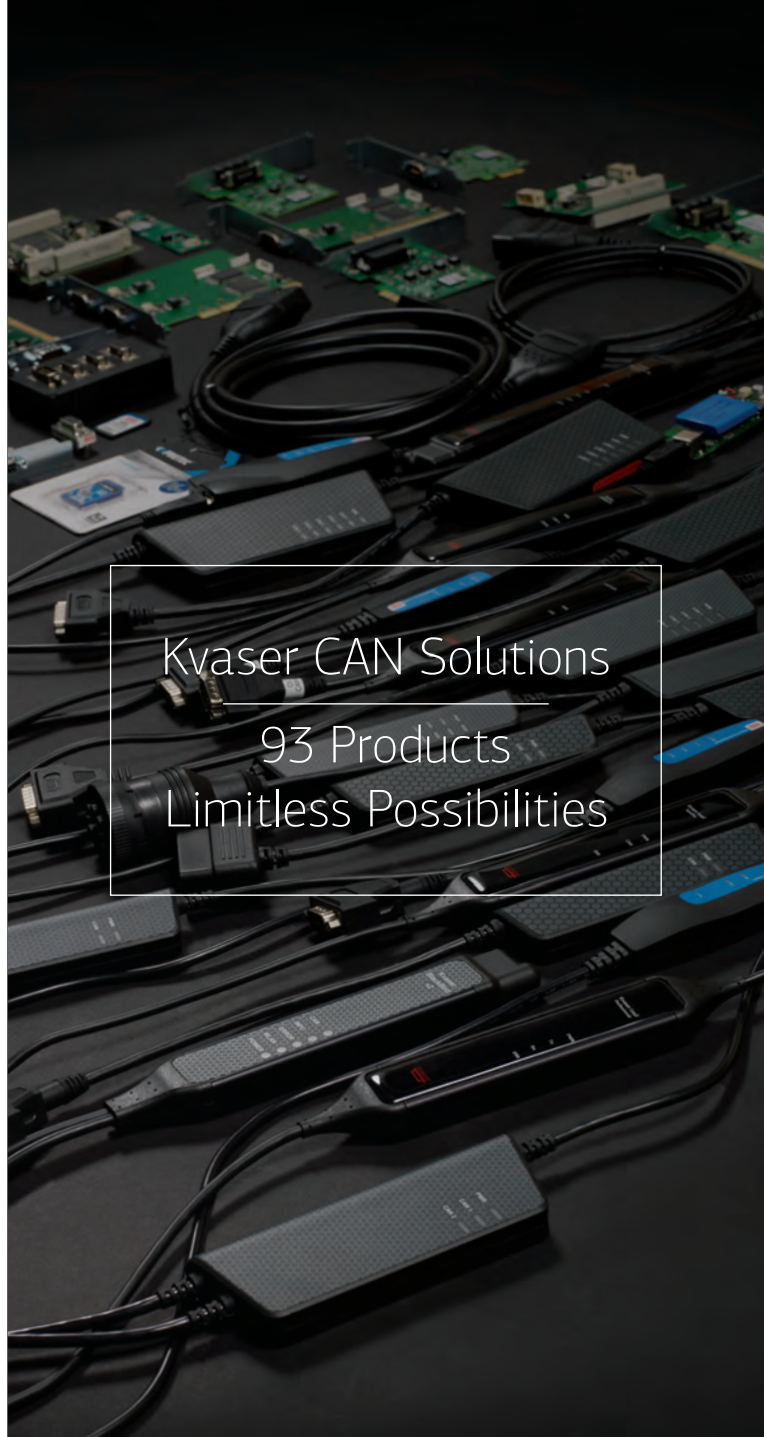

Kvaser CAN Solutions
93 Products
Limitless Possibilities

WHY CHOOSE A KVASER CAN INTERFACE?

The Widest Range of CAN and CAN FD Interfaces and Dataloggers, Plus:

- Free Support, Software and Software Updates for Life
- A Universal API
- An Open Ecosystem with Easy Toolchain Integration
- A Network of over 100 Software Partners and Qualified Sales Representatives



Linking Ethernet and CAN

Pressure of time and faster development processes require automotive measurement systems that can quickly be adjusted to different measurement applications. To achieve this, the system bus X-Link connects automobile standards.

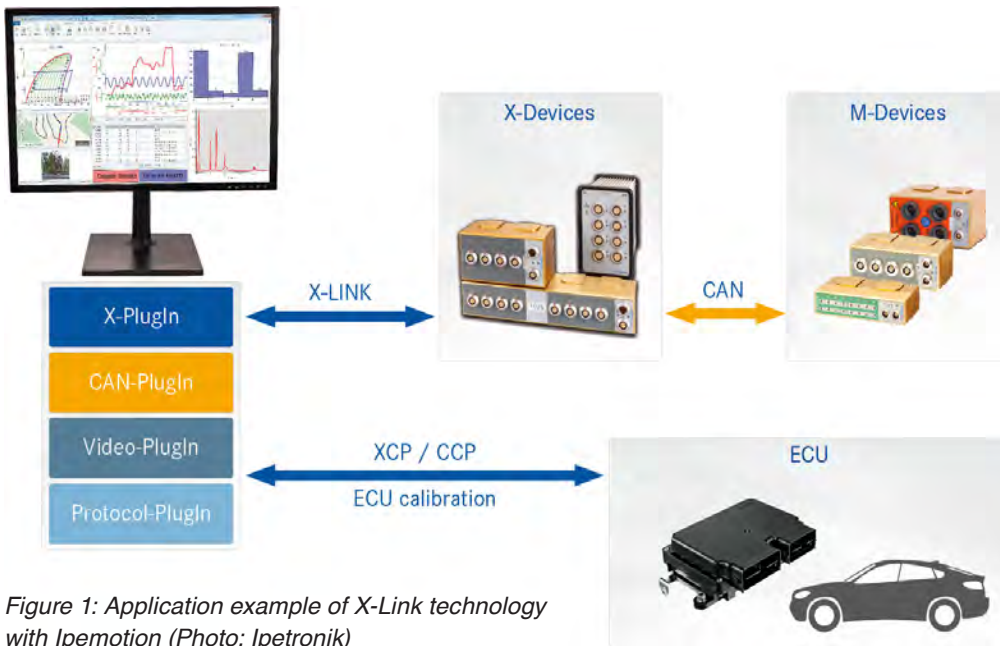

Figure 1: Application example of X-Link technology with Ipemotion (Photo: Ipetronik)

technology in combination with Ipemotion as a complete software solution or for powertrain applications, by a connection to typical engine application systems (Etas Inca, each software working with A2L files). System configuration is supported with Ipemotion as well as the Ipeaddon Inca 5 for Inca. The user is able to analyze measurement data according to the application either with Ipemotion or with the common analysis packages and software tools

The Ipetronik system bus X-Link provides a measurement system that connects automobile standards such as Ethernet, CAN, IEEE1588, and XCP. With this combination of technologies, a decentralized future proofed automotive measurement system is available. The system grows continuously with additional available technologies on the market, without having to redesign existing measurement modules.

X-Link technology stands for the time synchronous connection of fast Ethernet measurement technology with CAN measurement technology via only one bus to the Ethernet interface of the PC. The scalable hardware solution covers all areas of decentralized measurement

Vector CANape, NI Labview, AVL, ATI Vision, and Etas Inca. Besides the longtime proven CAN measurement technology for physical values such as pressure, temperature, voltage, and flow rate (up to maximum 2 kHz/channel), there is also an increased need of faster measurement channels up to 100 kHz/channel: for example, to optimize injection behavior or to perform vibration, oscillation, and acoustic measurements

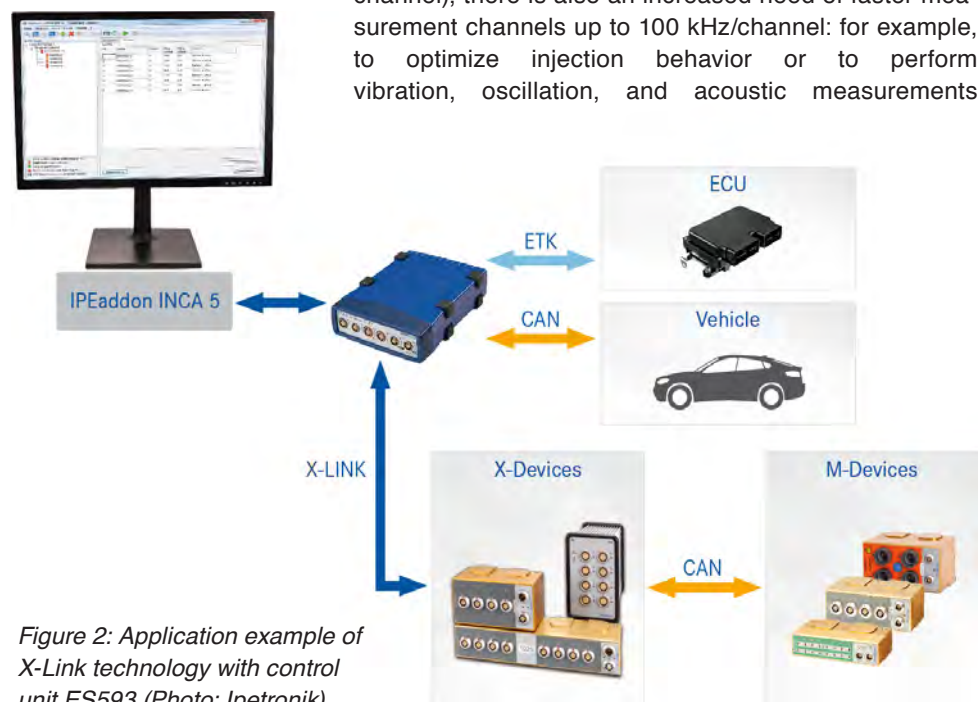

Figure 2: Application example of X-Link technology with control unit ES593 (Photo: Ipetronik)

(NVH applications) simultaneously to standard signals – with the eternal objective to further reduce test phases and costs.

Time synchronization of all signals as well as a familiar software interface avoid additional offline editing of signals and time-consuming induction and conversion steps. The user's proven and familiar workflow remains for a fast and flexible work. While existing bus systems only have a limited use for these requirements – because of limited channel sampling rates, missing configuration opportunities for individual devices, or limited range – available technologies fail if already existing measurement components have to be continuously used in the system. With X-Link technology, a measurement system is available, which ensures



Figure 3: Mx-Sens2 8
(Photo: Ipetronik)

a symbiosis of two bus systems and therefore an optimal workflow.

After many years of experience in control unit measurements via XCP-on-CAN, XCP-on-Ethernet and XCP-on-Flexray, this intelligent link of standards provides a

Table 1: Current possible sampling rates per channel in different software applications

Sampling rate/channel	IPEmotion	INCA	CANape (DAIO)	DIAdem (DAC XCP driver)	Test bench/ SW (with ECU-interface)
X-PlugIn	100 KHz				
IPEaddon INCA 5		100 kHz			
A2L	10 kHz	10 kHz	10 kHz	10 kHz	10 kHz
CANdb	2 kHz	2 kHz	2 kHz	2 kHz	2 kHz

☐ Ipetronik multi-platform driver

☐ XCP standard (XCPonEthernet)



Headquarters
Via Tito Speri, 10
25024 LENO (Brescia) ITALY
Ph +39 030 904511
Fax +39 030 9045330

info@cobogroup.net
www.cobogroup.net

hardware platform, which is able to run up to 100 kHz/channel sampling rate due to the used software application. Already existing CAN measurement technology can be used in the system time synchronously.

Usage and overview

Software connection: Through the multi-platform driver developed by Ipetronik, the Ipeaddon Inca 5 is available

besides Ipe motion and the X Plugin for the configuration and analysis of measuring data. Due to the universal concept of the driver more third party software applications are possible, which can be equipped with the same functionality and performance. With the multi-platform driver, the limits of standard XCP protocols (maximum 10 kHz/channel) can be removed (see Table 1).

Application with ES593: For powertrain applications, the widespread ES593 interface module from Etas serves as the ETK interface for the vehicle ECU. Different physical measured values are acquired time synchronously and in parallel. Inca is used as an application software. With assistance of Ipeaddon Inca 5 such a system can be realized fast and efficiently. The entire Ipetronik measuring chain can be configured in Inca and appears as an additional measurement system in the work area of Inca. Due to the CAN tunneling of CAN modules via Ethernet, another CAN input on ES593 for vehicle CAN data is available. High voltage modules by Ipetronik are able to cover characteristics of hybrid and e-drive technology.

X-Link provides a consistent tool chain for X and CAN measurement technology from configuration until analysis or reporting. Its modules can be integrated in existing software applications (Inca working area, Diadem circuit diagrams). Different migration paths according to specific applications are possible: the X module is



Figure 4: Sx-STG
(Photo: Ipetronik)

usable as a wholesome attendant to expand an existing CAN system or to cover higher sampling rates without buying another system. It can also be used for CAN monitoring. X devices dispose of the monitoring, for example for test bench applications. Measuring data can be visualized in parallel with a standard CAN interface on the test bench.

Currently, the Ipetronik X device family includes the Mx-Sens2 4 with up to 100 kHz/channel, as well as Sx-STG with up to 40 kHz/channel. The self-developed multi-platform driver provides the software driver basis to use the high sampling rates in all software packages for which there is a driver available. Thanks to the standardized Ethernet interface, the system is usable with a PC, a notebook, a test bench, and in future with Ipetronik logger platforms. The combination of proved and existing measuring technology with the newest technologies is future oriented. Users can decide to buy new measurement technology or integrate it into the existing system: the X-Link technology creates a basis for flexible and especially efficient measurement. ◀

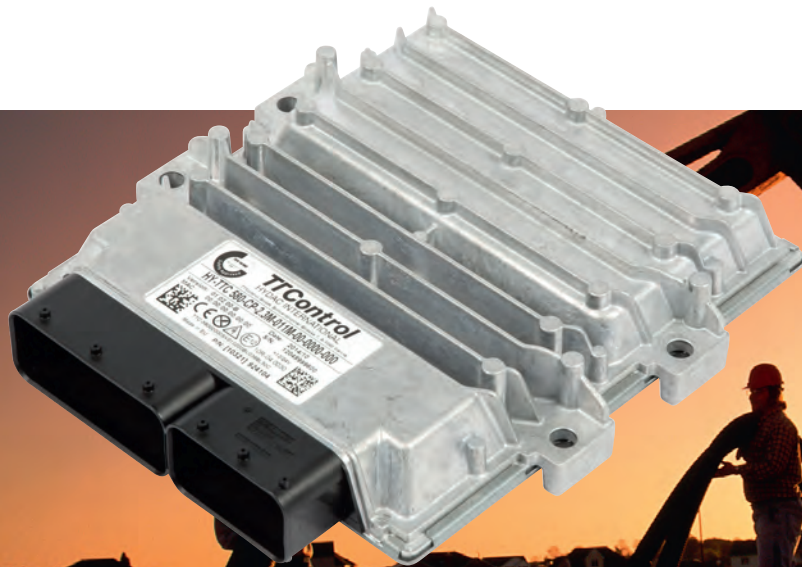

Figure 5: Mx-Sens2 4 (Photo: Ipetronik)



Author

Harry Stoerzer
Ipetronik
harry.stoerzer@ipetronik.com
www.ipetronik.com



Powerful Control Units for High-Safety Applications: HY-TTC 500 Family

Flexibility & Usability

- Single controller for whole vehicle for centralized architectures
- Extensive I/O set with multiple software configuration options per pin
- Open programming environments C, CODESYS® V3.x and CODESYS® V3.x Safety SIL 2

Safety

- TÜV-certified according to IEC 61508 (SIL 2) and EN ISO 13849 (PL d)
- ISO 25119 AgPL d certifiable
- CODESYS® Safety SIL 2 including support for CANopen® Safety Master and easy separation of safe / non-safe code
- Safety mechanisms in hardware to minimize CPU load
- Up to 3 output groups for selective shut-off in case of safety relevant fault
- Safety companion and safety mechanism in hardware

Connectivity

- Up to 7 CAN interfaces
- Automatic baudrate detection and configurable termination for CAN
- Ethernet for fast download and debugging purpose

Performance

- 32 bit / 180 MHz TI TMS570 dual core lockstep processor (ARM architecture)
- Up to 2.3 MB RAM / 11 MB Flash
- Floating-point-unit

Robustness

- Automotive style housing suited for very rough operating conditions
- Total current up to 60 A

www.ttcontrol.com/HY-TTC-500-Family



Safety
Certified
ECUs



General
Purpose
ECUs



I/O
Modules



Safe I/O
Modules



Operator
Interfaces

Enriching the Internet with CANopen

CANopen FD provides all attributes required for future embedded networking with the workflow defined by the CiA SIG CANopen IoT group and with the USDO functionality introduced by the CiA SIG application layer group.

Many application fields are faced with the fact that details of a traditional fieldbus system need to be accessible, e.g. for remote control via the end user's cell phone or for remote diagnostics. In addition, shortened development cycles make static, classic communication schema not feasible. To enable system maintainers to easily enhance their systems with modern devices and/or functionalities, a high degree of flexibility is required on embedded and deeply embedded system levels.

Because of tablets and smartphones, end users and system maintainers are used to a high degree of connectivity. Consequently, they would like use these devices to connect to their applications as well as for status inquires, triggering various system activities or doing system maintenance. The CiA working group SIG CANopen IoT is currently specifying a workflow that enables exactly such an accesses to a CANopen-based embedded system (see Figure 1).

The main focus of this workflow is to integrate as many of the already existing CANopen solutions as possible. For an external access to CANopen embedded systems, the first step is to identify the embedded system. Any embedded device can be identified if it supports a correct and consistent electronic data sheet (EDS) and/or device configuration file (DCF). These EDSs and DCFs are enhanced by a reference designator (RefDesignator). The RefDesignator assigns an application-specific, logical name to the device or even to the device's parameters. A gateway between the embedded network and the Cloud gets system knowledge via EDSs/DCFs that are enhanced by RefDesignators. Along with the so-called nodelist information, GraphML-capable tools can provide the application-related visualization of the entire control system. An IoT application accesses the IoT-to-CANopen gateway using its application server functionality (web server). The IoT application then becomes capable of discovering the sub-layered system based on the nodelist.graphml files. As soon as the system is known, the IoT application can use the remote CANopen access services to reach any sub-layered CANopen device. The gateway can provide this knowledge at any interface; either to web clients or CANopen managers (see Figure 2).

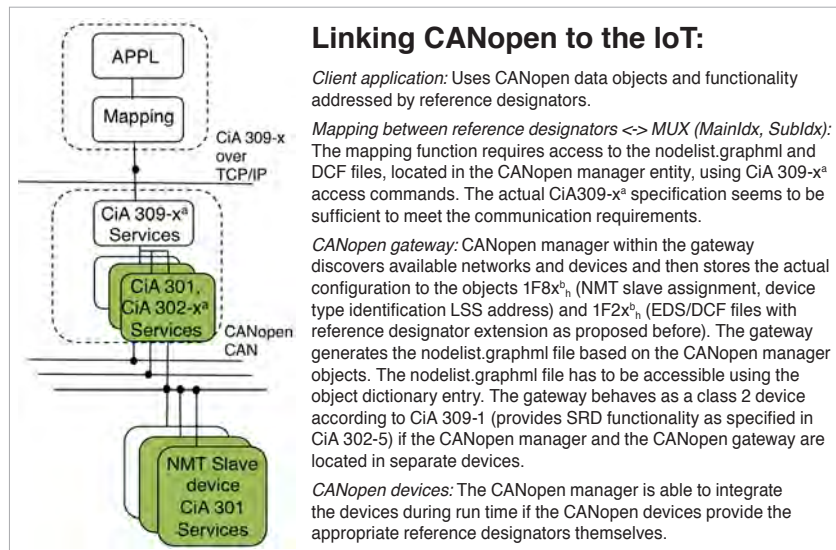

Figure 1: a: x is a specification parts number; b: x is a hex number

As soon as the web client has knowledge of the system architecture, the web client can provide the user interface to the end user. With it the user is able to stimulate the embedded CANopen network. This covers e.g. reading and writing CANopen device parameters; typically for diagnostic or configuration purposes. To avoid reinventing the wheel, the CiA SIG CANopen IoT relies on the CANopen network access services, provided in CiA 309 specification series. With the objective of using the CiA 309 services in existing web applications, the CiA SIG CANopen IoT is translating the CiA 309-3 ASCII-protocol to URI queries. In addition, the group provides translation guidelines for the CiA 309-3 ASCII protocol to an XML-schema. Using these mappings in existing web services frees the end user from any CANopen-specifics. The intended functional addressing allows accessing embedded systems by means of logical commands. Based on the RefDesignators, e.g. a gateway can translate these commands to typical CANopen services.

To make full use of IoT applications, typically lots of data has to be communicated on the embedded level as well. CAN-based parts of IoT applications benefit from the high data throughput provided by CAN FD. In addition, the applications benefit from the high flexibility provided by CANopen FD's universal service data object (USDO). In contrast to classical SDOs, there is no need to preconfigure USDOs. The communication partner can be chosen per access. CANopen FD devices are enabled to exchange any amount of data with one, several or all CANopen devices in the network. In addition, the inherent routing capability

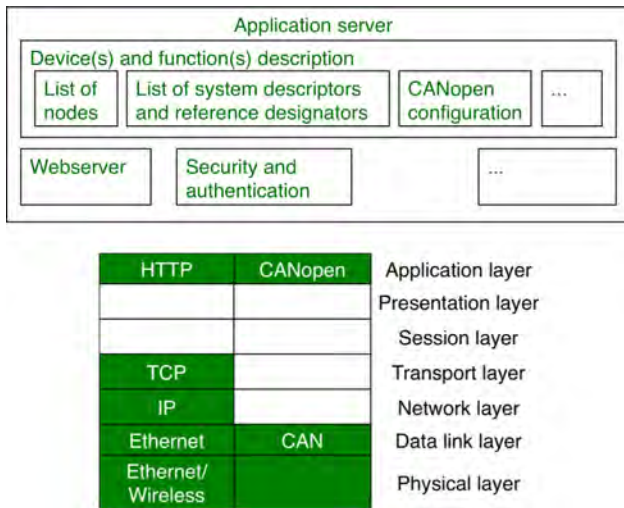

Figure 2: The IoT application can reach any sub-layered CANopen device

of USDOs is beneficial to IoT applications as well. Independently of the access point to a CANopen-based control architecture, any device can be reached as soon as the topology of the embedded network architecture is known. The CiA SIG application layer is currently specifying CANopen FD. It intends to publish the CiA 301 V5.0 by the end of this year.

In IoT applications often third parties require access to the system. To avoid any unauthorized access to the system, security issues have to be considered. CANopen already

provides several measures with regard to security. Several CANopen application profiles offer parameters which let end users reveal themselves to the system as a member of a specific user group, with specific system access rights. For systems where these basic measures are not sufficient, the CiA working group TF Security develops more comprehensive security measures for authentication and encryption, suitable for CAN- and CANopen-based embedded systems.

CAN in Automation is currently merging and enhancing existing CANopen functionalities, to allow adding CANopen-based embedded systems in modern control architectures. All CiA working groups appreciate any contribution and support that enables the group to provide the CAN community with comprehensive CiA specifications and implementation guidelines. Contacts to other working group members, established during the CiA specification maintenance, can be beneficial, not only in the currently running CAN-based project but during an engineer's entire working life. ◀

Author

Reiner Zitzmann
 CAN in Automation
headquarters@can-cia.org
www.can-cia.org



CAN Products for your requirements



**CAN-Repeater
CRep DS 102**



**CAN-LWL-Router
CG FL**



**CAN-Repeater
CRep S8C**

- Repeaters for different network topologies
- Stub line connection of networks segments
- Optical fibre connection of copper networks
- Cascadable star wiring for up to 24 CAN channels with star repeaters



Sonnenhang 3
 D-85304 Immünster
 Tel.: +49-8441-49 02 60
 Fax: +49-8441-8 18 60
www.ems-wuensche.com

Good to know:
The CANopen
vendor-ID is
mandatory

CANopen devices require a CANopen vendor-ID assigned uniquely by CAN in Automation. They give every CANopen device an individual identification name.

The CiA 301 application layer and communication profile specification says clearly that every CANopen device has to implement the identity parameter (index 1018_h). This parameter consists of four sub-parameters: vendor-ID, product code, revision number, and serial number. Only the vendor-ID is mandatory. CiA assigns it uniquely to manufacturers. For CiA members this assignment is free-of-charge. The other sub-parameters are optional and the unique assignment is the responsibility of the device manufacturer.

The unique device name (4 bit x 32 bit) is required for some protocols. For example, the Layer Setting Services (LSS) protocols need to address the CANopen devices in order to assign the node-ID via the CAN network or to configure the bit-rate dynamically. In some applications, it is required to double-check the connected CANopen devices regarding the product code and the revision number, in order to start a mission-critical application. Sometimes the serial number is used as a criteria by the NMT master device to start the system. Possibly, some authorities have ►



The CANopen vendor-ID is like a fingerprint: a worldwide unique identification for CANopen devices (Photo: Fotolia)

approved just a range of serial numbers (e.g. a charge of devices).

What happens if you integrate a CANopen interface module from third parties into your product? A representative example: An electrical drive with an off-the-shelf interface module or a USB-dongle has to connect to a host controller. Normally, this interface module or dongle implements the vendor-ID of the third-party supplier. Consequently, the tool that reads the identity parameter does not displays your company name, but the vendor-ID of your supplier. You might not care about that. But if you implement LSS protocols or node claiming protocols, your device needs a worldwide unique name. This can only be achieved by implementing a unique product code, revision number, and serial number. Consequently, the supplier has to assign a unique product to you. To be honest, I have not seen too many suppliers willing to assign the product codes uniquely to their customers. If there are two devices with the very same "name" in the CANopen network, LSS will perhaps not work. In medical, military, or other mission-critical applications in subsea or outer space, this is not acceptable. The same problem may occur if you use the vendor-ID provided by the CANopen protocol-stack vendor, no matter if this is commercial source-code, open-source software, or an embedded protocol stack in a PLCopen runtime program.

CAN in Automation (CiA) has assigned about 1200 CANopen vendor-IDs. It is tricky to keep track of all of these vendor-IDs, which is why CiA registers a responsible

person for each of them. Of course it happens that companies are acquired and merged or that a part is sold. In all these case, it would be nice if CiA would be informed about these changes. Of course, a change of the contact person should also be reported. Unfortunately, this does not always happen, which keeps us busy. ◀



Author

Holger Zeltwanger
CAN Newsletter
headquarters@can-cia.org
www.can-cia.org

CAN Products for your requirements



CTrans OL



EtherCAN CI-ARM9



CPC-USB/embedded

- **Economical solutions for series applications**
- **Optimized for industrial applications**
- **Solutions for stationary and mobile use**
- **Software support for bus-analysis, measurement and control**



Sonnenhang 3
D-85304 Immünster
Tel.: +49-8441-49 02 60
Fax: +49-8441-8 18 60
www.ems-wuensche.com

CANopen for functional safe drives

The recently released CiA 402-4 is the device profile specification for drives and motion controllers with safety functionality. CiA 402 is one of the best-specified motion control profiles.



Operating principles

A safety drive implements one or more of the defined safety functions. It behaves as commanded by the host controller transmitting the safety controlword in an SRDO. The drive confirms this SRDO with an SRDO containing the safety statusword. In addition, the safety drive may provide local safety inputs, which can cause the transition in a safety state. This is indicated in the safety statusword as well. The local safety commands may overwrite the commands remotely received from the host controller.

In December 2015, the members of CiA's SIG (special interest group) motion control released the CANopen device profile for drives and motion controllers with safety functionality. This profile is the fourth part of the CiA 402 specification. It specifies the safety-related process data, the safety-related configuration parameters, and the safety-related diagnostic information. The safety-related process data is transferred via SRDOs (safety-related data objects) as specified in EN 50325-5 (CANopen Safety). Communication parameters (e.g. direction, frequency) and the mapping (content) of the SRDOs are defined in CiA 402-4 as well.

The document is based on the ETG 6100.2 Generic Safety Drive Profile from the Ethercat Technology Group (ETG). The defined safety functions accord to the IEC 61800-5-2. The naming and the assigned indices and sub-indices of the parameters are as far as possible the same as in the ETG document. Devices compliant with the CiA 402-4 profile have to be compliant with CiA 402-2 i.e. implement all mandatory parameters and support one or more of the defined operating modes. It is required that the safety drive supports the emergency functionality and the PDOs as defined in CiA 402-3. It is recommended to support the heartbeat functionality. Bit 19 in object 1000_h indicates whether a CiA-402-compliant drive supports the safety functionality.

Each bit of the 8-bit safety controlword requests the activation and deactivation of dedicated safety functions of the drive. Up to eight safety controlwords may be implemented. The relation of the controlword-bits to safety functions is configurable by means of the ▶

CiA 402-4 safety functions

SAR	safe acceleration range
SBC	safe brake control
SCA	safe cam
SDI	safe direction
SDIn	safe direction negative
SDIp	safe direction positive
SLI	safely-limited increment
SLP	safely-limited position
SLS	safely-limited speed
SLT	safely-limited torque
SMA	safe maximum acceleration
SMS	safe maximum speed
SOS	safe operating stop
SS1	safe stop 1
SS2	safe stop 2
SSM	safe speed monitor
SSR	safe speed range
STO	safe torque-off



All
you need for
CAN

IXXAT[®]

More than you expect!

For over 25 years IXXAT has offered one of the largest CAN portfolios.

- PC/CAN interfaces
- Gateways, repeaters and bridges
- IO modules
- Analysis and diagnosis
- Protocol software
- PLC expansions



Discover more:
www.all4CAN.com

Development services
25 years of CAN experience –
benefit from our know-how!

CiA 402 CANopen device profile for drives and motion control

The five-part set of profile specifications standardizes the functional behavior of controllers for servo drives, frequency inverters, and stepper motors. It also introduces several operation modes and corresponding configuration and process parameters. The profile description includes a finite state automaton (FSA) that defines device's behavior for each state. The drive state determines which commands are accepted and whether high power is applied. States are changed when a controlword from the host-controller is received or due to internal events. The current state is indicated by the statusword. The controlword and different command values (e.g. for velocity) are mapped into default RPDOs (receive process data objects). The statusword and different actual values (e.g. position) are mapped into TPDOs (transmit process data objects).

Since the end of 2007, the first three parts of the profile have been internationally standardized in the IEC 61800-7 series. Currently, the second edition (December 2015) of the IEC profile is available. The CiA 402-2 corresponds to the IEC 61800-7-201. It describes all functional behavior including the FSA and all process data and configuration parameters. CiA 402-3, published in IEC 61800-7-301, contains mainly the PDO definitions for generic drives, servo drives, frequency inverters or stepper motors. In CiA 402-5, CiA has developed a third set of standardized PDOs optimized for easy system integration. CiA members have the option to work on further development of the CiA 402 (parts 1 to 3) specifications.

CiA 402-4 specifies the safety drive parameters and dedicated safe-communication object parameters (SRDO: safety-related data objects) as defined in EN 50325-5 (CANopen Safety). This approach is based on the Generic Safety Drive Profile from the Ethercat Technology Group (ETG).

Currently, the members of the CANopen SIG (special interest group) motion control are working on the CiA 402-6. This part specifies the PDO mapping for "future" drives working in CANopen FD systems. Such PDOs may contain up to 64 byte of data. For a certain drive type, the data previously transferred in several PDOs may be now submitted within just one PDO. Further motion control experts are invited to join the group.

On the one hand, CiA 402 is one of the best-specified motion control profiles. On the other hand, the multitude of optional functions and parameters limits the exchangeability of devices compliant to CiA 402. Some vendors implement only a subset of the mandatory functions and parameters but still claim CiA 402 conformity.

controlword mapping parameters. Two bits in the safety controlword-1 are fixed. One of them contains the STO (safe torque-off) command and the other contains the host controller's acknowledge for errors reported by the drive. The states (activated or not) of dedicated safety functions are provided in the safety statuswords. The relation of the statusword-bits to safety functions is configurable by means of the statusword mapping parameters. Analogously to the safety controlword, two fixed parameters in the safety statusword 1 provide the STO status and the error acknowledge status of the drive.

The actual safe process parameters provided by the drive optionally include 16-bit or 32-bit values for position, velocity, acceleration, and torque (only 16-bit). The document also defines the physical units for time, position, velocity, acceleration, and torque values. These are expressed as 32-bit values structured according to definitions given in CiA 303-2. The latter is a CANopen recommendation for representation of SI units and prefixes and is available also for CiA non-members.

CiA 402-4 specifies a mechanism to check the safety application configuration for each function. Certain parameters indicate whether and for which safety drive function the configuration has failed. The check is done using a CRC-16-CCITT (cyclic redundancy check) polynomial. Data to be checked includes the configurable parameters as well as the controlwords and statuswords for a certain safety function. Implementation and configuration hints for the safety-related devices are given in the CiA 319 document.

Safety drive functions

The safety drive functions are defined in detail in the ETG document. The main safe drive function is the STO (safe torque-off) whereby the immediately torque-off on the motor may be accompanied by an SBC (safe brake control) command to close the brakes. The SS1 (safe stop) and SS2 functions provide certain time (e.g. delays, time to velocity zero), velocity, and deceleration definitions to safely stop the drive. SS1 and SS2 also allow closing the brakes via a chosen SBC command. With activation of the SOS (safe operating stop) function, the monitoring of the current position and optionally of the speed is started. The position (and speed) is held in certain limits. Thus, the drive system stays in the control loop and retains the torque. After the activation of SSR (safe speed range), the drive starts decelerating until the velocity is in defined limits. The velocity (and optionally deceleration) monitoring is started at least after the configured delay has elapsed. Activation of SAR (safe acceleration range) function starts the acceleration monitoring. The acceleration is held within the specified limits. Optionally the maximum acceleration can be monitored. The SLS (safely-limited speed) and SLP (safely-limited position) functions cause the drive to decelerate (if required) and monitor whether the velocity respectively position is held within the defined limits. The SMS (safe maximum speed), SLT (safely-limited torque), and SMA (safe maximum acceleration) limit the maximum motor speed, torque, or acceleration. With the activation

of SLI (safely-limited increment), the current position is latched and the monitoring is started. The position is hold within a limited window. The drive may move only a limited number of increments. The functions SDIp (safe direction) and SDIn enable the motor movement only in the corresponding (positive or negative) direction. The function SSM (safe speed monitor) provides the information whether the speed is within the defined limits or not. Analogously, the SCA (safe cam) informs whether the position is within the defined limits. ◀

Author



Olga Fischer
 CAN in Automation
headquarters@can-cia.org
www.can-cia.org

CAN Newsletter Online

The CAN Newsletter Online sister publication provides brief product-related information. For more details please visit www.can-newsletter.org.



4-axis module
Complies with CiA 402 and features local I/O

The Stepnet Plus (SP) 4 motion controller is based on dedicated FPGAs, which enables a footprint of only 101,6 mm x 76,2 mm x 20,8 mm.

[Read on](#)

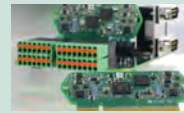

Motion controller
Available for CANopen applications

Schneider Electric's Lexium Motion Module (LMM), a programmable motion controller, is now available as a CANopen version. It supports CiA 301 and CiA 402.

[Read on](#)



IEC 61800-7-201/301
CiA 402 drive profile updated and extended

Edition 2.0 of the IEC 61800-7 series has been published. Additionally, the CiA 402-4 functional safety extension has been released.

[Read on](#)

LIN & CAN Bus simulation for test and production

Windows or Linux

I/O Digital

RS-232

automotive meets automation

Distribution China: Hongke Technology Co., Ltd
 Distribution USA: FEV North America Inc.

Ph: +86 400 999 3848
 Ph: +1 248 293 1300

sales@hkaco.com
 sales@dgeinc.com

www.hkaco.com
 www.fev.com

Lipowsky Industrie-Elektronik GmbH Ph: +49 6151 935910

info@lipowsky.de

www.lipowsky.de



CAN is taking over light vehicles

CAN is mainly used in vehicles: automotive, marine, or heavy industry. Now there is a new kid on the block: e-bikes and scooters, commonly called light vehicles.



(Photo: Comodule)

Comodule is a company based in Berlin, Germany, and Tallinn, Estonia, which develops connectivity technology for the light vehicle industry. The light vehicle industry is growing faster than any other mobility related sector. In the last 50 years, bicycle production has by far exceeded the production of cars. The main reason is urbanization: since 2007, more people live in cities than in rural areas. Simply put, there is just not enough space for cars in metropolitan areas and people need smaller personal vehicles to get around. This need has sparked the fast development of the 2-wheeler product, the introduction of electrically assisted bicycles (in short: e-bikes), as well as the electrification of the loud and smoky scooters. Smart city planning has brought many public sharing systems across the world. At the end of 2014, 712 cities had public bicycle sharing systems with more than 800 000 bikes.

Electrification has brought new challenges to the industry. The most important of them is the stable communication between components. An e-bike has three main electrical units: a battery with its management system, a motor with its controller, and an HMI to display information to the user. In many cases these components are not produced by the same supplier and need a convenient way to communicate. In the automotive industry, there are common standards to follow. There are strong, industry-wide organizations and corporates who work together to unify systems. The light vehicle sector is still more like the wild-wild west without standardization. Depending on the brand, you can find almost all commonly known communication protocols: I²C, UART, EIA-485, SPI, CAN, and others. Additionally, a UART-based protocol called Bikebus was developed. This is a great technological hurdle to building universal hardware solutions for the industry.

At Comodule, we have spent two years to develop a hardware solution that can support a wide range of different protocols on the same hardware unit. Although this is possible, it is by no means an optimal solution as low-level protocols have their limitations. We are happy to see that the industry has realized that a more flexible and stable system can be developed for the small extra cost of CAN hardware.

A good example of this is a project at hand with a German electric scooter developer. The vehicle will have up to three interchangeable battery units. In fleet operations like delivery, the batteries can be changed between different vehicles. Inside the battery unit, a management system controls each individual cell while on the vehicle level

the main control unit manages three different battery units with potentially different capacities. At the same time, the Comodule solution has to make sure that live information is available online for each single battery unit as well as for every vehicle.

Because there can be up to three Comodule telematics units in the vehicle at the same time, our hardware units have to coordinate which one of them sends all the information to the Cloud. This kind of complex system can only be built on top of an advanced protocol like CAN, where every single unit has its own specific ID and can broadcast data to a common bus. The biggest hurdle for IoT adoption is not the firmware nor server deployment but the communication. Today, M2M networks are based on 2G or 3G GSM. Both of these are aged technologies not meant for low power and data transmission. Secondly, there is no global standard. The US has decided to close down 2G networks while Europe is discussing closing down 3G. This creates a situation where it is impossible to build cheap global telematics units.

Luckily, the GSM industry has made rapid progress. In June 2016, the umbrella organization of telecoms 3GPP completed the standardization of the NB-IoT, a narrow-band radio technology developed for the Internet of Things (IoT). In short, this means cheap hardware (\$ 5), low-power consumption (5 years on an AA battery), and minimum data consumption. Nokia and Tele2 are deploying one of the first ever nation-wide NB-IoT networks right here on our home-turf in Estonia, while Comodule exclusively tests and validates this technology. ▶



Figure 1: The data analytics platform tracks and monitors vehicles remotely and performs over-the-air software updates (Photo: Comodule)

Figure 2: The full connectivity ecosystem enables integration of different vehicles and communication protocols (Photo: Comodule)



In the future wireless communication and connectivity will be immensely important. In many cases direct connections to the Cloud might turn out cheaper and more robust than wiring a physical connection and using a single transmission source. Think about the scooter battery example: with NB-IoT we would connect all batteries directly to the cloud saving a lot of time during the custom development on the firmware level. The transition from firmware to cloud managed creates opportunities and challenges for all parties. For a protocol like CAN, its future success depends on how it can act as a bridge between wired and wireless connections. On the other hand, there is definitely a huge potential in the CAN-to-cloud transition over the new NB-IoT standard. We at Comodule are working hard to be the first company to offer a stable out-of-the-box solution that has a promising future in all parts of industry, not only bikes or scooters. We think that the full deployment of NB-IoT will take the world from talking about IoT to full-scale adoption. We can't wait...

Comodule is a technology company that develops connectivity platforms for bicycle and scooter OEMs. The company employs 15 people with backgrounds from automotive electronics, to Linux kernel development, mobile payments, and electric racing cars. The founders came together while building racing cars at university as

part of the Formula Student series. The founding team spent years in the Formula Student Team Tallinn and brought the Estonian team to place third out of 500 teams from all over the world. The 4WD electric racer had 1200 Nm, an extremely complex CAN-based distributed battery management system, and raced from standstill to 100 km/h in less than 3 s.

Comodule has developed and mainstreamed a scalable connectivity platform that allows collecting, analyzing, and visualizing vehicle data. The solution is based on a universal communication electronics unit and modular software. The company's connectivity solution consists of three parts: communication electronics, a smartphone application, and a Cloud platform for data analysis. Integrated Bluetooth, GPS, and GSM provide a simple and secure connectivity to control the vehicle wirelessly. We are able to receive information from the CAN protocol and send it directly to the GSM server. The mobile application visualizes this data, provides range estimation for electric vehicles and can track the vehicle if stolen. The Cloud-based data platform enables the manufacturer to take advantage of usage and vehicle data, gather information, and hopefully make better marketing and product development decisions. ◀



Figure 3: Automotive grade hardware is small in size and low in power consumption (Photo: Comodule)

Author

Kristjan Maruste
Comodule
kristjan@comodule.com
www.comodule.com



Position sensors can CANopen

Non-contacting position sensing has become a well-established technology for industrial automation and mobile machines. Durable linear position sensors and rotary position sensors have also made great strides.

The buzzwords of late are fieldbus functionality and miniaturization. Sensor technology specialist Novotechnik for instance presents a number of innovations and advancements of this type: single-channel, partially or completely redundant touchless linear position sensors, and rotary position sensors, which are now available with a CANopen interface. The company also offers flat rotary position sensors, which are suitable for applications in machine and automotive engineering.

The allrounder: a touchless rotary position sensor

The rotary position sensor RFC 4800 (Figure 2), which determines the measurement angle based on the positional change of a magnetic field, has proven itself in quite diverse applications. It can be found in countless applications in machine engineering and plant design as well as in mobile applications. This sensor, which conforms to the protection requirements of IP69K, is even utilized for hydroelectric power plants. These compact sensors are now also available with CANopen interfaces, opening additional diagnostic avenues to the user, and providing additional features, such as cam switch, limit switch, speed data, etc. The CANopen version is available in single-channel or dual-channel designs, with one or two connections. This allows for a stub connection or the loop-through of the bus. There are also different plating options available: The selection includes models with cable outlets, as well as 5-pin M12 connectors, and the AMP or Deutsch connectors favored for mobile applications. In the near future, the CAN protocol SAE J1939 for utility vehicles will be supported as well.

This durable rotary position sensor demonstrates versatility and integratability in other aspects, too. The physical separation of the completely potted, 15 mm sensor component and the magnetic position marker allows for sensor placement in up to 1,5 mm distance from the

Figure 2: The rotary position sensor RFC 4800 with CANopen interface (Photo: Novotechnik)

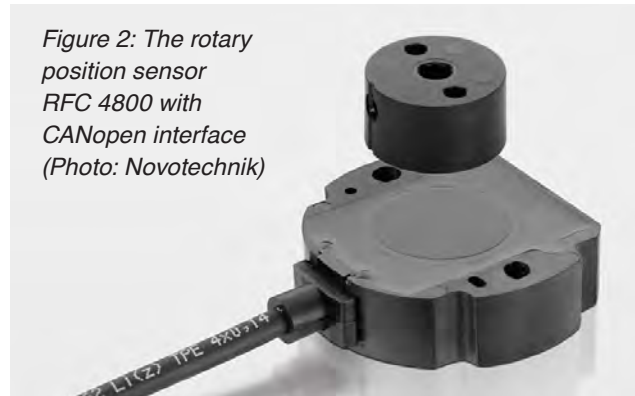

position marker. With the help of an available stronger position marker, larger separation distances of up to approximately 4 mm are possible. A marking indicates the correct alignment with the sensor. Since neither shaft nor bearings are required, and because the sensing distance is variable, application-specific installation tolerances are not a problem. The non-contacting sensing of the measurement angle eliminates mechanical wear and tear, and yields absolute measurements over the entire 360° range. These measurements are provided with a 14-bit resolution (0,022°). In addition, a high resolution speed signal is available to the control system. The independent linearity is $\pm 0,5\%$, with a repeatability of 0,1 %.

Linear position sensor for hydraulic cylinders

The TIM series linear position sensors for absolute measurements are magnetostrictive linear position sensors suitable for position sensing in the pressure ranges of hydraulic cylinders (Figure 1). These non-contacting sensors, which are practically free of wear and tear, are now also available with a CAN interface (i.e. SAE J1939). In addition, node ID, bit-rate, transmission mode, transmission cycle time, gradient, and direction, as well as other

Figure 1: Linear position sensor with CANopen functionality for hydraulic cylinders



(Photo: Novotechnik)

Figure 3: The linear position sensors of the TP1 series are available for measuring ranges of 50 mm to 4250 mm

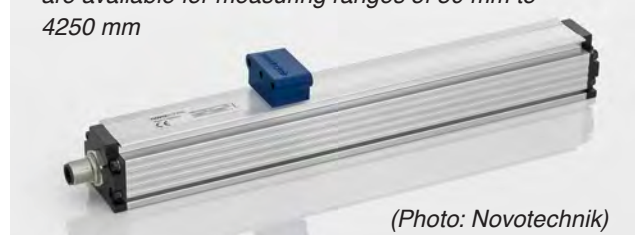

(Photo: Novotechnik)



Figure 4 : Nowadays, CANopen is utilized even for rather tough applications, which are expected to become the typical applications for the non-contacting rotary position sensor RSX-7900 (Photo: Novotechnik)

parameters are freely configurable, and diagnostic and limit features are available. Typical applications include shaft and steering cylinders of agricultural or forestry vehicles and machinery as well as lifting jacks in the control systems of hydraulic cultivators.

The component series is offered in lengths of 50 mm to 2500 mm and can withstand many hydraulic fluids. The sensors are precise and reliable even under tough environmental conditions. Their linearity is $\pm 0,04\%$,

with a repeatability of 0,1 mm, independent of the measuring distance.

The sensors can withstand operating pressures of up to 350 bar, and thanks to a plug-in connector system, they can be installed quickly and without soldering, crimping, or use of screws: The insulator of the M12 connector is already connected to the sensor's lead wires and passed to the outside through a bore in the cylinder housing. The connecting flange just needs to be plugged in.

Heavy-duty rotary position sensor

Nowadays, the CANopen technology is utilized even for rather tough applications. These are expected to become the typical applications for the non-contacting rotary position sensor RSX-7900 with CANopen interface (Figure 4). All standard bus diagnostic features as well as additional features (cam switch, limit switch) are available for use. The sensor function itself can be reliably monitored; an example is the detection of real values directly at the steered shaft of electro-hydraulic steering systems. Potholes, road salt, and other untoward road factors do not interfere with the functioning of these sensors, so that the diagnostic capabilities of the CAN protocol can be utilized for these applications as well.

This heavy-duty sensor is available for measuring ranges of up to 360 °, and it allows for continuous mechanical rotation. It is available in single-channel or dual-channel designs. The completely redundant version can be utilized for applications where safety is a concern; it complies with the requirements of ISO 13849 PL-d. With a diameter of 79 mm and its height of 35 mm, this component can be integrated into the mechanics of construction, agricultural, and forestry machinery, as well as into the rudder steering systems of maritime vessels and the like. Type E1 approval has been obtained from the German department of motor vehicles (KBA).

Magnetostrictive linear position sensors

The latest generation of linear position sensors, namely the TP1 series (profile standard design, Figure 3), and the TH1 series (hydraulic cylinder standard design, Figure 5), are ▷

CAN YOU IMAGINE THE POSSIBILITIES? WE CAN!

CANopen®



The PFC200 Controller from WAGO – Compelling, Fast and Intelligent

- High processing speed
- Programmable with CODESYS 2 and e!COCKPIT (based on CODESYS 3)
- Configuration and visualization via Web-server
- Integrated security functions
- Robust and maintenance-free

www.wago.com/pfc200



Figure 5: The linear position sensor series TH1 with CANopen interface is not influenced by external conditions and suitable for direct installation into pressure cylinders

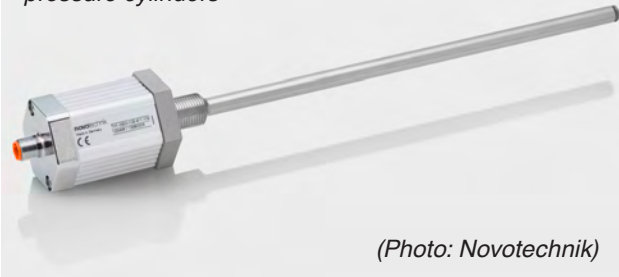

(Photo: Novotechnik)

available with CANopen as well. All the advantages of the CANopen protocol, combined with measurement capabilities of these systems, allow the plug-and-play use of these sensors even where demanding measuring tasks are concerned.

Linear position sensors utilizing the Novostriktiv principle are available in measuring ranges of up to 4250 mm. They meet the protection requirements of IP67/IP68. The permissible operating temperatures are -40 °C to +85 °C. The internal sensor resolution is independent of the measuring range and amounts to 1 µm, which can be a deciding factor, especially where large measuring distances are concerned.

Extreme miniaturization – ideal for OEM applications

Many applications call for rotary position sensors that are non-contacting, small in size, and preferably inexpensive. The spectrum of possible uses ranges from steering angle and gear sensors in vehicles over medical-technical applications to motorized doors, grippers, or maritime applications. This is where the non-contacting RFD-4000 series can shine (Figure 6). These sensors are non-contacting and utilize the Hall effect. They feature a measuring range of 360°, a 12-bit resolution, and an independent linearity of ±0,5 %. And they are available in single-channel, partially or completely redundant designs. The housing measures 7 mm in height. The matching position marker also features a small footprint, with a diameter of 22,2 mm and

Figure 6: Small and inexpensive touchless rotary position sensors are desirable for many applications, from steering angle and gear sensors in vehicles over medical-technical applications to motorized doors, grippers, or maritime applications

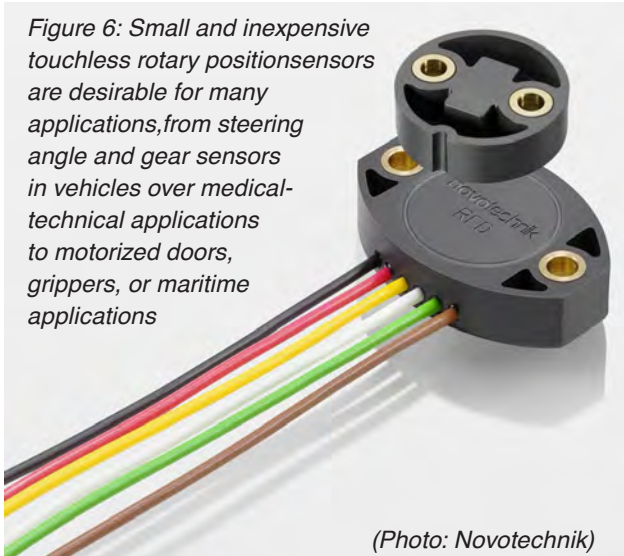

(Photo: Novotechnik)

a height of 5,6 mm. Functionality is not compromised by lateral installation offsets of up to ±1,5 mm. This allows for an easy integration of the miniaturized sensor into many OEM applications. Single leads molded into the housing are available for the electrical connections. ◀

Authors

Ellen-Christine Reiff
Redaktionsbüro Stutensee
Stefan Sester
Novotechnik
sester@novotechnik.de
www.novotechnik.de



CAN Newsletter Online

The CAN Newsletter Online sister publication provides brief product-related information. For more details please visit www.can-newsletter.org.



Bauma 2016

Various sensors with CANopen

At the Bauma, Gefran (Italy) launches three series: angular, inclination, and displacement sensors. They are specifically designed for mobile hydraulics applications.

[Read on](#)



Bauma 2016

Tape sensors with integrated pulley

ASM (Germany) has enlarged its Positape tape extension sensor product line with an additional feature: the WBR models are equipped with an integrated pulley mounted directly onto the sensor.

[Read on](#)



Wire-actuated encoder

Stroke measurement in the hydraulic cylinder

The wire-actuated encoder SGH10 by Siko measures absolute, direct cylinder strokes in hydraulic cylinders. With this measurement system, cost-intensive drilling of the piston is no longer required.

[Read on](#)



Solar tracking systems

Capture the sun!

Concentrated photovoltaic as well as concentrated solar power systems make use of sun tracking technologies. Some of these tracking control systems are based on CAN networks connecting motors and sensors.

[Read on](#)

ifm electronic

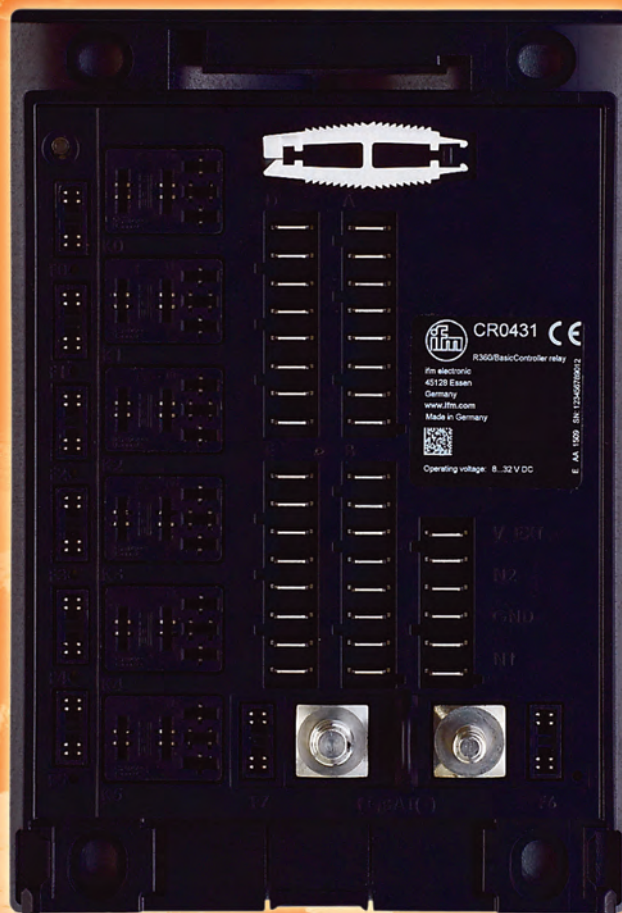

Look what we have for you!

An absolute must-have!

ecomatmobile BasicController^{relay}: modular mini controller with powerful relay outputs with diagnostic capabilities for mobile applications. Direct connection of sensors and actuators without further external wiring, powerful CAN interfaces, programmable to IEC 61131-3 with CODESYS. Can be extended with other components, such as the BasicDisplay. With E1 type approval of course.



www.ifm.com/gb/ecomatmobile_basic

Phone: +49 0800 16 16 16 4

On the safe side with IEC 61508

As the successor to the EN 954-1, ISO 13849-1 is the most important standard for the design of control systems in the field of machine safety. However, is it always the most suitable?

Manufacturers of mobile machines are faced with the task of upholding the legal specifications of the Machinery Directive and the Product Liability Act. For implementation, these refer to the state of the art technology which is described by the harmonized product standards. Therefore, some manufacturers of sensors, actuators, and control units provide their customers with already certified products for use in safety-critical applications. As the successor to the EN 954-1, the ISO 13849-1 is here the most important standard for the design of control systems in the field of machine safety. But is it always the most suitable?

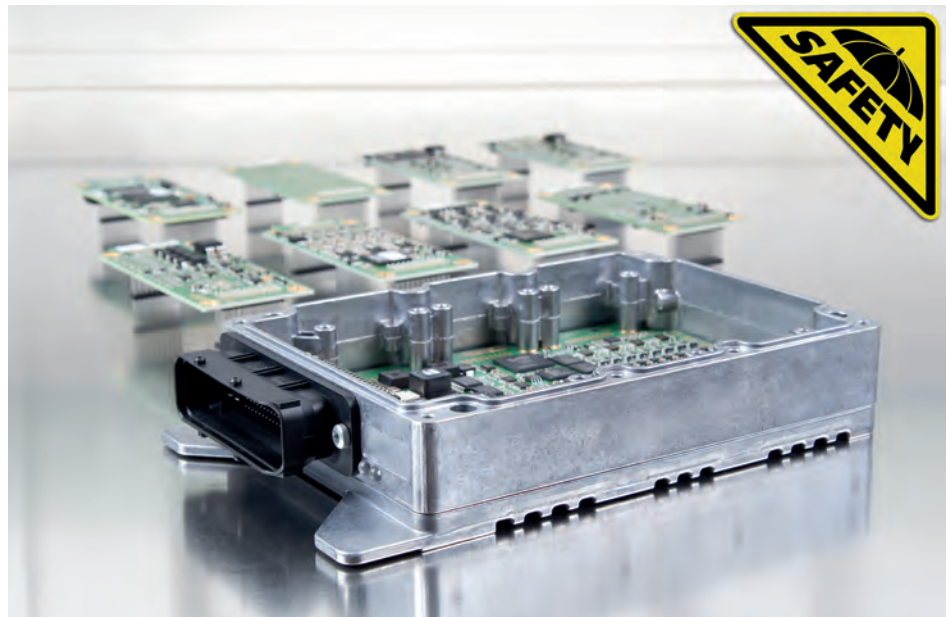

Figure 1: Freely programmable control unit ESX-3XM Safety with extension boards (Photo: STW)

Prior to a manufacturer being able to consider which subcomponents they will use, they must first concern themselves with an analysis of the hazards resulting from their machine. For this purpose, they can use ISO 12100, which defines the general design principles for the risk assessment and risk reduction for the creation of safe machines. The risks determined in this way are evaluated and are reduced to an acceptable extent with the aid of safety classifications. The defined safety functions must then be technically implemented.

Here the question is whether the application of ISO 13849 is always the most sensible method. For manufacturers, the primary fact focused on is that this standard, contrary to its sister standard, IEC 62061, is not only limited to electrical / electronic systems in its application, but is also applicable to mechanical, pneumatic or hydraulic systems. Initially, this appears to be an advantage; nevertheless it cannot be disputed that the electronic control technology dominates in most applications today.

Let us consider the specific disadvantages of the standard ISO 13849. It is applicable to safety-related parts of control units on all types of machinery. In accordance with the EU Machinery Directive 2006/42/EC, this does not include vehicles and methods of transport which are intended for use in public road transport, but rather

only machines mounted onto these vehicles (e.g. cranes, loading ramps etc.). ISO 13849 does not contain this limitation, but nevertheless its focus is evidently on stationary machinery, as it's recognizable from several requirements laid down in the standard, and is also reflected in the BGIA Report 2/2008 "Functional safety of machine control units – application of the DIN EN ISO 13849". Safety functions are seen more as additional functions instead of the attempt to safely design the primary functions of the machine. And yet the attachment of light grids to mobile machines, for example, barely makes sense, so what is the alternative?

In the case of self-propelled machines, we differentiate between agricultural machines (e.g. tractors), forestry machines (e.g. harvesters), municipal machines (e.g. snow ploughs, cleaning machines), construction machines (e.g. excavators, wheel loaders), lifting and conveying machines (e.g. mobile cranes, concrete pumps), and special machines (e.g. snow cats). With ISO 25119, a product standard for safety-related parts of control systems already exists for agricultural and forestry machines and municipal vehicles. It combines the safety architecture known from ISO 13849 in the form of categories with the well-tried safety lifecycle of the Generic Safety Standard IEC 61508, and likewise displays analogies to the automotive safety standard ISO 26262. ▶

Table 1: Division of the standards

Standard	Type*	Focus	Scope
ISO 12100	A	general design principles for risk assessment and risk reduction	safety of machinery
ISO 13849	B	safety-related parts of control systems (SRP/CS)	safety of machinery
IEC 61508	A	electrical, electronic and programmable electronic safety-related systems (E/E/PES)	functional safety
IEC 62061	B	safety-related E/E/PE control systems (SRECS)	safety of machinery
ISO 25119	C	safety-related parts of control systems (SRP/CS)	machinery for agriculture and forestry
ISO 26262	C	safety-related electrical and/or electronic (E/E) systems	road vehicles up to 3.5 tonnes
IEC 61800-5-2	C	E/E/PE elements of safety-related electrical power drive systems with adjustable speed	power drive systems (PDS)

* Type of standard: A = basic standard, B = sector standard, C = product standard

The other applications can be subdivided into those with and without road approval. One prerequisite for road approval is the type approval, e.g. according to Regulation (EC) No. 661/2009 “concerning type-approval requirements for the general safety of motor vehicles, their trailers and systems, components and separate technical units intended therefor.” Here, too, as in the Product Liability Act, “state of the art science and technology” is referred to – and therefore to the harmonized standards. For motor vehicles up to 3,5 t, we have ISO 26262, which has already been at least used as a basis by several commercial vehicle manufacturers, for example for risk analyses. In the field of mobile machines, designs are developed optionally according to ISO 13849, IEC 62061 or IEC 61508, whereby the latter in particular is recommended for drives. The reason for this is the assumption that the path is easier from there to ISO 26262, and, as generally known, in its next version this is also to be applied to Heavy Commercial Vehicles.

However, this is not the only argument for the use of IEC 61508 in the field of machine safety. According to DIN ISO/TR 23849:2014-12, the following applies: “Every complex sub-system which has been designed according to IEC 61508 with the relevant SIL can be integrated as a safety-related part in a combination of SRP/CS, which has been designed according to ISO 13849-1 or as a sub-system in a SRECS, which was designed according to IEC 62061”. This statement also applies in the same way for the amalgamation of the standards in IEC ISO 17305. Even although the completion of the new standard is still in progress, we are this initially armed with IEC 61508-compliant products for its introduction.

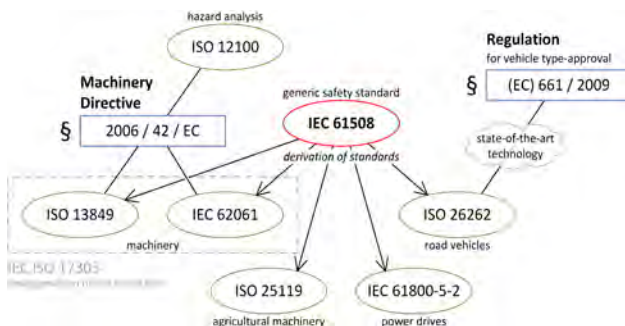

Figure 2: Relation of the standards (Photo: STW)

One valid option

A further point is that we currently do not yet have a product standard for the power electrification of mobile machines which can be extensively applied. IEC 61800-5-2, for example, excludes the application of electrical power drive systems with adjustable speeds in rail drives and electrical vehicle drives. In such cases, only the application of IEC 61508 or a derived sector standards, such as IEC 62061, remains a valid option.

Finally, we should consider the fact that safety-related communication protocols are also increasingly being used in mobile machines. Accordingly, ISO 13849-1 refers to IEC 61508-2, which in turn provides a choice of two data communication architectures. With the White-Channel, the entire transmission path must be developed compliant to the standard, whereby with the Black-Channel, only the end points are considered safety-relevant and the transmission is protected via a special protocol. In both cases, for non-rail applications, IEC 61784-3 “Functional safety fieldbuses” is referred to the principles of which have been implemented in the CANopen Safety standard EN 50325-5, for example. It is important at this point that the systems which should communicate with each other reliably must comply with the requirements of the standard. For Black-Channel transmission this means that at least the software has to be developed according to IEC 61508-3 and executed in a safe context.

In summary, it can be said that the manufacturers of mobile machines are indeed currently managing well with ISO 13849, but that the additional use of IEC 61508 brings many advantages for future challenges. With control components which have been certified accordingly, manufacturers can secure their investments long-term, because the systems can be supplied to different sectors without having to be developed compliant to different standards. ◀

Author



Philipp Luger
 Sensor-Technik Wiedemann
info@sensor-technik.de
www.sensor-technik.de

From developer's tool to HIL test system

The demands on the development and testing of embedded systems have never been as high as today. Therefore, the performance of the test process has to be enhanced, for instance through the use of scalable test systems.



Figure 1: iSy-Tester – a scalable HIL (hardware-in-the-loop) test system (Photo: iSyst)

The demands on the development and testing of embedded systems have never been as high as today. Therefore, the performance of the test process has to be enhanced, for instance by the use of scalable test systems.

Because of digitalization and artificial intelligence, the technical progress in the field of embedded systems development is increasing rapidly, for example in automotive applications. The complexity of functions and the development effort are rising constantly. So, to reach the necessary depth of testing in an economic manner, module and system tests have to be realized by the highest possible grade of automation in the process. The general demands on the tests and the complex control systems have increased the demands on the development as well.

When developing the software that will be implemented in the target hardware and in order to bring the control system into an operating condition that is usable for the developer, more and more complex emulations of the system environment by simulation are necessary. Because of the continuously rising demands on embedded systems and because of the automatically generated software out of models, efforts in the test process escalate disproportionately high.

Composition of the test system

Figure 2 shows the structure and the composition of the HIL-test systems described here. Test systems like these are widely spread in the automotive and aircraft industry. The real

time system is the central point of the test system. This computer performs the environmental simulation in real time (typical cycle time between 500 μ s to 1 ms). Besides simulation, this system provides the interfaces for the device under test (DUT), too. On the one hand, these interfaces could be analog, digital, or PWM-ports. On the other hand, there are applications of different bus systems like CAN, Flexray or Ethernet. The signals of the interfaces are used to emulate the environment of the DUT. Analog signals can be used to emulate the data of analog sensors.

The real time system provides the connection of these signals to the DUT. Because of the different levels of signals, power and load, a special signal conditioning has to be used. Besides the conditioning of signals and power, a filter can be used optionally. Another part of the system performs the load simulation. Different kinds of actors and loads are present, like nozzles and electric motors. It is possible to use the original loads or an electronic load simulation. The simulation of the load is controlled by the real time computer.

The error injection unit is placed between the load simulation module and the DUT. With this module it is possible to emulate shortcuts and disconnections at the loads to test the detection of faults and the reaction of the system. The fault injection module is controlled by the real time computer, too. Another part of the test system is the power supply system for the DUT. This system can be controlled by the real time computer, to simulate voltage drops. It is permanently used in the automotive field to simulate drops of the battery voltage, generated by the starter or when heavy loads are activated or deactivated. ▶

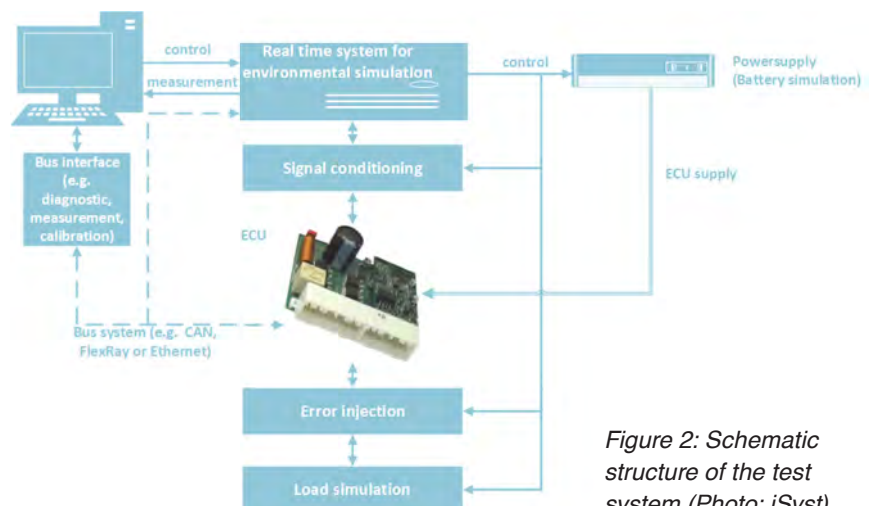

Figure 2: Schematic structure of the test system (Photo: iSyst)

The last part of the test system is the control computer unit. This personal computer is mostly based on Windows. It is used to control automatic tests as well as manual tests. The automation of the tests can be done by different tools (e.g. iSy-Tester or sepp.med Cetes++) and with different description languages (e.g. Python or UML). Other tools are used for monitoring the activity of communication on the bus (e.g. Vector's CANalyzer) or to be able to get access to the software of the control system during the term (e.g. Vector's CANape, iSystem's Winidea, or Lauterbach's Trace32). These tools widen the possibilities of the automatic tests.

The implementation of the environmental simulation can be achieved by using different programming languages with a fixed cycle time of typically 1 ms. According to the demands on the test, the complexity of the model of the environment and the processing power, cycle times down to 50 μ s are possible. Within this time period all inputs and outputs are handled as well as the calculation of one simulation step of the complete simulation model.

In contrast to other suppliers, iSyst's iSy-Tester is able to use different hardware platforms for real time computing. Starting with systems based on an ARM Cortex A8 processor (e.g. for basic test systems or developer workplaces) and going all the way up to PCs for industrial use with Intel Core i7 processors, iSyst supports a broad range of architectures. The abstraction of the hardware is carried out by the real time middleware system Gamma V, delivered by the RST company. Besides this hardware abstraction, the middleware provides a timing model for the deterministic application of the environment model, based on Linux. The Simulink blockset for Gamma V, delivered by iSyst, enables the porting of Simulink models (from other test system platforms too) to the iSy-Tester. These models can be used on different hardware platforms (ARM or x86) without the necessity of adopting the models. Figure 3 shows the typical implantation of such a real time system.

The link of the hardware to the Gamma V middleware is done by so-called plugins. These plugins accomplish the configuration of the hardware and provide I/O ports as channels. Within the middleware, these channels are linked to the so-called PVs (process variables). These are the interface for the environmental model and the test automation. According to the configuration, a PV can be mapped for example to an analog output or to a signal within a CAN message.

Another possibility of the middleware is the transparent cross linking of different systems by Ethernet, also possible using a Windows system. This function allows an easy linkage of the real time system of an iSy-Tester to the controlling computer. Via the middleware the controlling PC has a direct access to all PVs of the real time system. In co-operation with the test automation system iTest Studio, delivered by iSyst, it is possible to program, execute, and document the test automation. Figure 4 shows the diagram of the system implementation.

Simulation of CAN nodes

In this chapter, the application of the tester for the simulation and test of the CAN communication of a DUT is described. The configuration of the CAN communication is carried out by a XML data in the CAN plugin. Figure 4 shows \triangleright



CAN in Automation

Knowledge transfer

CiA provides several education services for different purposes. Besides scheduled seminars and conferences, also in-house seminars are offered.

CAN 2020: The future of CAN technology

	Date*	Language	Location*
CAN 2020	2016-09-27	English	Berlin, DE
CAN 2020	2016-10-06	English	Lyon, FR
CAN 2020	2016-10-27	German	Essen, DE
CAN 2020	2016-11-08	English	Utrecht, NL
CAN 2020	2016-11-28	English	Shanghai, CN

CiA training center

	Date*	Language	Location*
CAN/CAN FD	2016-09-28	German	Nuremberg, DE
CANopen	2016-09-29	German	Nuremberg, DE
CAN/CAN FD	2016-10-18	English	Antwerpen, BE
CANopen	2016-10-19	English	Antwerpen, BE
CANopen safety	2016-10-20	German	Nuremberg, DE
CAN FD	2016-10-25	German	Nuremberg, DE
CAN/CAN FD	2016-11-15	English	Milan, IT
CANopen	2016-11-16	English	Milan, IT
CANopen subsea	2016-11-17	English	Austin, US
CAN/CAN FD	2016-12-07	German	Nuremberg, DE
CANopen	2016-12-08	German	Nuremberg, DE

* Subject to change without notice.



For more details, please, contact the CiA office at events@can-cia.org

www.can-cia.org

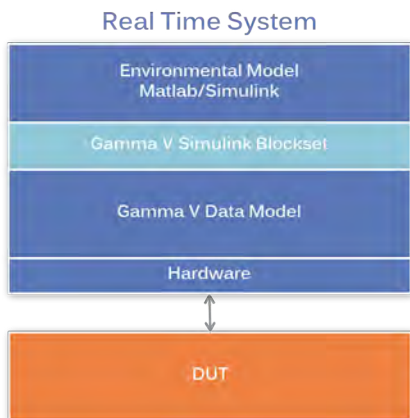

Figure 3: Test system – environment simulation (Photo: iSyst)

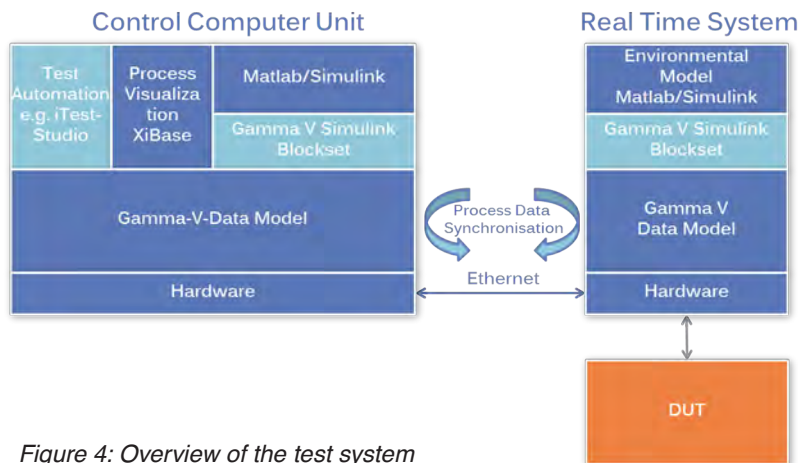

Figure 4: Overview of the test system (Photo: iSyst)

the configuration of a CAN frame with the ID 220_n and a length of 2, to be sent by the test system. The middleware does not only allow access to the reference data of the CAN frames (as raw data and split to the signals) but also provides the channels for changing the length (e.g. length of the frame with the ID 220_n), the approach of the cycle time for the cyclic transmission of the CAN frames (e.g. period of the frame with the ID 220_n) and timestamp (e.g. timestamp of the frame with the ID 220_n). These channels are directly available as PVs in the middleware. The XML file for configuration can be created manually or generated using the description files, e.g. of a DBC file.

The content of a CAN frame is composed directly via the PVs by the test automation system. It is also possible to implement the dynamic behavior of other control systems or even protocols like CANopen by the model of the environment. In the case of CANopen, it is easily possible to detect the power on of the DUT and to switch the DUT automatically by NMT (network management) to the status “in operation”.

Following test cases are typically used when testing the CAN network at the HIL:

- ◆ Detection of Bus-off, if a short between CAN_L and CAN_H occurs,
- ◆ Restart of the communication after Bus-off,
- ◆ Test of the range and translation for the signals,
- ◆ Test of the error detection for the check sums,
- ◆ Test of the error detection for the counter of the messages or toggle bits,
- ◆ Test of the error detection for erroneous length of the messages,
- ◆ Test of the error detection for erroneous cycle times.

```
<message direction="output" id="0x220" isExtendedID="false" isRemoteFrameRequest="false" length="2">
  <value description="Frame_0x220_Payload" name="Frame_0x220_Payload">true</value>
  <timestamp description="Frame_0x220_Timestamp" name="Frame_0x220_Timestamp">true</timestamp>
  <period name="Frame_0x220_Period">0</period>
  <length name="Frame_0x220_Length">true</length>
  <signal endianness="little" type="uint8" mask="0xFFFF" name="Frame_0x220_Signal" description="Signal of Frame_0x220"/>
</message>
```

Figure 5: Configuration of the CAN frame

Working environment for software development

In this chapter an example for a smaller test system for testing an inverter to control an electric motor is described. As seen in Figure 6, the test system consists of a 19-inch rack with the real time system (Cortex A8 – 1 GHz) and the trigger circuit as well as two electric motors, which are degenerated (engine and load). The inverter, in this case the DUT, is controlled by the test system via the CAN network using the CANopen protocol. It is working according to device profile CiA 402. The implementation of the environmental simulation to control the network management (NMT), to transmit and receive the PDOs was carried out in real time by Simulink as well as the configuration by SDO. The implementation of the tests occurs on a connected Windows PC and Python.

On the one hand, the system was able to run tests of the engine control. By using the load engine, it was possible to force different load torques and to simultaneously detect the number of revolutions and the control mode. On the other hand, the focus of the test was laid on the function of CANopen. There were different tests performed at protocol level as well as at the level of CiA 402. The main interest for the tests was the state machine according CiA 402. In this manner, test scripts for the automated test of all valid and invalid state changes were generated. So it is possible to detect a correspondent misbehavior. A big advantage was seen in the possibility of the combination of the test at the level of the communication protocol and the level of the function. Here is an example of an error recovery detected.

First, the inverter was set to the NMT state and the state machine of the CiA 402 to the state „Operation enabled“, which widely deactivates the CANopen ▷

communication (beside NMT commands). Thus, it was no longer possible to control the driving engine. The forced revolution speed was constant. In the view of safety this is a critical stage.

Example of use – fullsize HIL

As an example for a fullsize HIL system, a system for the test of an electronic control unit (ECU) for a special purpose vehicle is described, which uses CleANopen as a version of CANopen among others. Figure 7 shows the system within the 19-inch rack and the connected control computer. The used real time system is based on a modular hardware according to the μ TCA standard. The execution of the model of the environment is carried out by a Core i7-2655LE processor on a processor board. The data is stored on a SSD (solid state drive). In addition, an I/O-board for digital and analog I/Os and a CAN-board with four CAN channels is used.

This system was used to test the functional requirements of the ECU. That includes tests of the communication according CANopen/CleANopen. Due to the concept of the iSy-Tester in combination with the Gamma V middleware, the reuse of many modules for the environment simulation of the engine test rig for the CANopen function was possible. Beside this reuse of the environmental model, test scripts for the automated test of the engine test rig could be transferred. Different levels of communication were tested, starting with physical errors on the CAN network (e.g. shorts) and the related Bus-offs as well as the fault free communication after a Bus-off.

As a next step, the network management was tested, focusing on the correct connection and disconnection of the communication channels (e.g. PDO and SDO) according to the NMT stage. At the end, the correct mappings of the data within the PDOs were tested in the transmission and receive directions. Besides the original bus communication, the functional behavior of the ECU could be tested using digital and analog I/Os.

Reuse and scalability

As shown in the previous examples, it is possible to reuse former developed functions for the environmental simulation on test systems of different performance and functions. Due to the modular concept of the different hardware platforms are supported. The use of the real time middleware Gamma V provides a unique interface for the simulation of the environment, which is connected with the world of Simulink by the Gamma V block set. On the other side Simulink provides an effective surrounding for the platform independent modeling of the environmental simulation. In combination of these components it is possible to use the same model of the environment on test systems fitting the size of working place up to a Fullsize-HIL-system. Besides the model of the environment, test scripts also can be transferred from project to project and from DUT to DUT.

The presented iSy Tester allows realizing test systems which are scalable in the sense of costs and performance and the extensive reuse of the environmental



Figure 6: Working environment of an engine test rig (Photo: iSyst)



Figure 7: Fullsize HIL system (Photo: iSyst)

model as well as test scripts. The performance starts with compact test systems for use as working place environment using Cortex-A8 or Cortex-A9 processors and realized with costs of about € 10 000 up to fullsize HIL systems using industrial PCs with Core i7 processors for some € 10 000.



Author

Dr. Kristian Trenkel
iSyst Intelligente Systeme
info@isyst.de
www.isyst.de

CAN components for the CAN FD trend

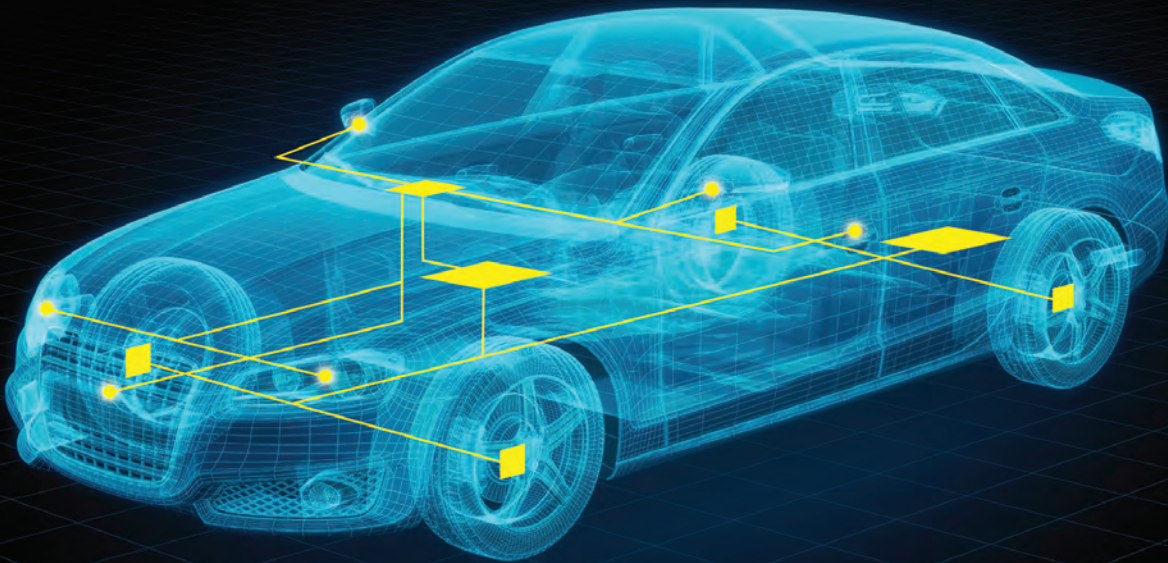

Atmel/Microchip offers transceivers for use in automotive applications requiring speeds as high as 5 Mbit/s. They provide differential transmit and receive

(Photo: Microchip)

To serve the rapidly increasing bandwidth requirements in automotive networks, Atmel (recently acquired by Microchip Technology) has developed the ATA6560 and ATA6561 high-speed CAN FD transceivers that provide an interface between a CAN-protocol controller and the physical two-wire CAN network. The transceivers target use in automotive applications requiring speeds as high as 5 Mbit/s and the ability to provide differential transmit and receive capability to a micro-controller with a CAN-protocol controller. Due to their excellent electromagnetic compatibility (EMC), the devices guarantee operation as fast as 2 Mbit/s without a common-mode-choke (CMC). Radiated-emission test passed at 2 Mbit/s without a CMC.

The ATA6560 and ATA6561 transceivers provide choices for all types of high-speed CAN networks, especially in nodes requiring a low-power mode with wake-up capability via the CAN network. They provide improved electrostatic-discharge (ESD) performance; a low quiescent current; passive behavior to the CAN network when the supply voltage is off; the ability to directly interface with micro-controllers with voltages of 3 V to 5 V (ATA6561). They also offer three operating modes and dedicated fail-safe features. Figures 2 and 3 show the typical application circuits for the CAN transceivers, which are available in SO8 and DFN8 packages with wettable flanks, allowing an automatic optical inspection of the solder joints.

Automotive-grade MCU with CAN FD controller

In addition to offering CAN-FD-capable transceivers, Atmel was among the first to introduce automotive-grade micro-

controllers (MCUs) with embedded CAN FD controllers. The SAMV7x MCUs are micro-controllers based on 300 MHz ARM Cortex-M7 processor cores, which bring industry-standard 32-bit processing performance, improved accuracy, increased power efficiency, and higher levels of system integration – including up to 2 CAN FD controllers – to automotive applications. The MCU leverages Atmel's 17-year history as an ARM-core licensee with 8-bit embedded flash micro-controllers to create solutions for tomorrow's demanding automotive networking, touch interfaces, and connectivity applications. ▶

References

- [1] "CAN FD Positioned for Success," The Hansen Report on Automotive Electronics, Vol. 25, No. 10, December 2012/January 2013, Portsmouth, New Hampshire
- [2] [Hartwich, Florian, "CAN with Flexible Data-Rate," CAN Newsletter 12/2, June 2012, Nuremberg](#)
- [3] [Hammerschmidt, Christoph, "Ethernet succeeds in automotive environments," EETimes Automotive Europe, October 14, 2011](#)
- [4] ["Ethernet to gain ground in automotive applications, Bosch predicts," EETimes, February 5, 2011](#)
- [5] [Butzkamm, Cornelius and Bollati, David, "Partial Networking for CAN bus systems: Any saved gram CO2/km is essential to meet stricter EU regulations," iCC 2012](#)

Classical CAN and CAN FD

Today's cars are becoming increasingly complex and are undergoing a continuous addition of features. These factors have led to the need for more electronic control units (ECUs) in vehicles, and this combination of requirements can push a CAN's communication bandwidth to its limit. Solving this problem by using multiple CAN buses or by switching to another protocol requires a lot of system-design effort and the replacement of hardware and software. CAN FD extends the Classical CAN standard (Figure 1) and permits significantly higher data rates, enabling faster firmware upgrades and leaving most of the software and hardware, especially the physical layer, unchanged.

CAN FD improves the bandwidth usage of the CAN protocol, the dominant bus system in the automotive industry. To achieve the increase in the protocol's bandwidth efficiency, CAN FD frames support dual-bit-time capability and normal bit time during the arbitration phase. The bit time is identical to that of the current CAN protocol. This time includes those fields in which multiple devices can transmit simultaneously: at the arbitration start and acknowledgement end. Those fields are the start-of-frame (SOF) bit, the 12-bit arbitration field, three control bits, the acknowledge bits, the acknowledge delimiter bit, the 7-bit end-of-frame (EOF) field, and the 3-bit interframe space.

Further, CAN FD allows a reduced bit time in the data phase and other fields, and the timing requirements for these fields are less stringent because CAN FD guarantees that only one device communicates on the bus. These fields are: a control bit; a 4-bit DLC (data length code); payload data; and a CRC-field (cyclic redundancy check), which, depending on the data length, is 21 or 25 bits. CAN FD also increases the payload capacity. The data-field length increases from 8 bytes to 64 bytes, improving the efficiency of the CAN protocol. To take advantage of this improvement, the system software also requires updating.

All the benefits of the 32-bit ARM Cortex-M7 processor core embedded in the MCUs can quickly be diminished without the right peripheral functions and mix of peripherals, and SAMV7x MCUs include a variety of peripherals to meet the functional needs of automotive electronic control modules while also ensuring reliable operation across the entire automotive temperature range in compliance with the AEC-Q100 specification. Among the list of embedded peripherals are one or two (depending on device variant) CAN FD controllers.

In addition to CAN FD network support, the MCU also supports interfacing to several other automotive networks, making it a suitable choice for connectivity bridging or gateway applications. The network interface options include:

- ◆ High-speed USB: The MCU supports high-speed USB host or device mode operation, with an integrated PHY for reduced system cost;

All you CAN plug



CANopen®

CAN™

CAN-PCI/402 CAN-PCIe/402

- up to 4 high performance CAN interfaces powered by esd Advanced CAN Core (ACC)
- DMA busmaster and MSI support
- High resolution hardware timestamps

CAN-USB/400

- 2 high performance CAN interfaces powered by esd Advanced CAN Core (ACC)
- CAN error injection capabilities
- High resolution hardware timestamps
- IRIG-B time code option

The esd Advanced CAN Core (ACC) powered CAN/400 board series is also available in CompactPCI, CompactPCISerial, PMC, XMC and µTCA form factors.

Operating Systems

esd supports the realtime operating systems VxWorks, QNX, RTX, RTOS-32 and others as well as Linux and Windows 32/64 Bit systems.

CAN-Tools

Our efficient CAN monitoring and diagnostic tools for Windows like CANreal, COBview, CANplot, CANscript and CANrepro are delivered together with the Windows/Linux driver CD free of charge or can be downloaded at www.esd.eu.



esd gmbh
Vahrenwalder Str. 207
30165 Hannover
Germany
Tel.: +49-511-3 72 98-0
info@esd.eu
www.esd.eu

US office:
esd electronics, Inc.
70 Federal Street - Suite #2
Greenfield, MA 01301
Phone: 413-772-3170
us-sales@esd-electronics.com
www.esd-electronics.us

www.esd.eu

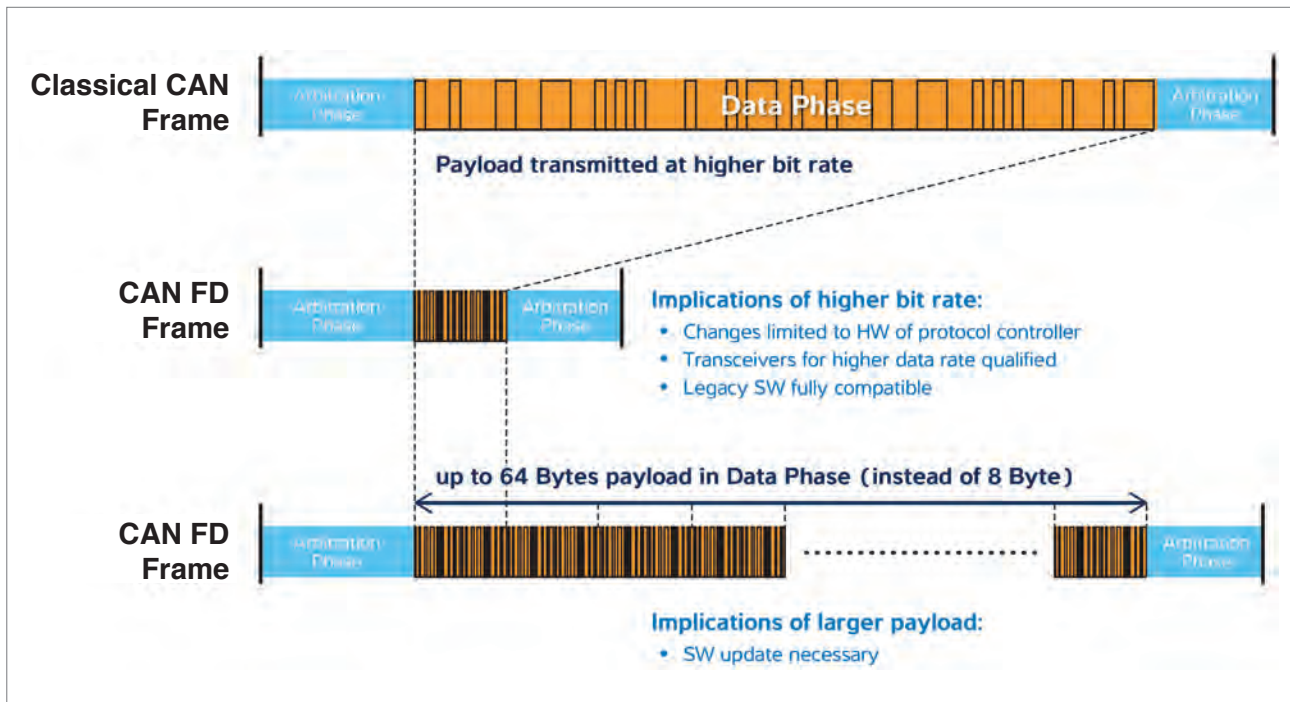

Figure 1: Comparison of Classical CAN and CAN FD timing (Photo: Microchip)

- ◆ Ethernet media access controller (GMAC): The GMAC supports all features required of an Ethernet media access controller;
- ◆ Media LB: The Media LB peripheral included on the MCU provides efficient access to a 3-wire Media LB

bus, through which the micro-controller can ultimately establish connection to a Most25 or Most50 network for in-vehicle streaming applications.

System architecture features

To address the needs of complex automotive real-time embedded systems, the core and peripherals of an MCU must be tied together by a coherent system architecture that is optimized for managing real-time events common to embedded systems while minimizing processing latency. The SAM7x MCUs include features to do this.

Multi-layer bus: A high speed multi-layer bus matrix is at the heart of the system architecture. The multi-layer bus matrix connects the elements of the system (e.g. the core, the system RAM, the Flash memory) through multiple master and multiple slave ports. This arrangement allows for concurrent accesses from different masters to different slaves. As an example, the CPU can access the Flash at the same time that data is being transferred from the CAN controller to the system RAM.

Direct memory access: An additional system architectural feature included in automotive ARM products to further reduce the processor load to service peripherals is the use of direct memory access (DMA) technology. DMA allows for transfers between peripherals and memories or between memories without CPU involvement. Once configured, DMA transfers are typically triggered automatically by hardware events. Each available CAN FD controller integrates its own DMA controller, which operates as a master on the multi-layer bus. This configuration allows seamless “behind the scene” movement of entire CAN messages to the system RAM without any processor core involvement.

Tightly coupled memory: In addition to instruction and data caches, the MCUs include an SRAM architecture. This architecture allows the available SRAM to be

Migration from Classical CAN to CAN FD

The introduction of CAN FD will not affect today’s vehicle networks, such as LIN (local-interconnect network) and Most (media-oriented systems transport). However, migration paths are necessary to include CAN FD into current CAN networks. A CAN-FD-compliant node can accept Classical CAN frames and CAN FD frames without any errors, but a Classical CAN node will generate an error frame on the network in the presence of CAN FD frames. OEMs can use any of several approaches to ease migration efforts to a true CAN FD network.

OEMs should note that new ECUs deployed in the network must be CAN-FD-compliant, meaning that both the CAN controller and the CAN transceiver must be FD-compliant and still operate within the Classical CAN communication-frame format. Also, when upgrading the software, OEMs should integrate new CAN drivers that will have only minimal or no effect on the upper layers. Further, limiting the payload to 8 bytes can restrict any software changes to the CAN driver only, and achieving higher data rates requires a software update to incorporate the CAN FD frame format. OEMs can realize a true CAN-FD-compliant network by using software updates to support payloads as large as 64 bytes for high bandwidth efficiency, by using CAN-FD-qualified transceivers for much higher data rates or by implementing both of these methods.

partitioned in different configurations, under software control, between system memory and "tightly coupled" memory, according to the needs of the system. The partition allocated as system memory is shared with the entire system though a direct connection to the multi-layer bus matrix. On the other hand, the partition allocated as "tightly coupled" memory has a direct connection to both the data and instruction buses of the processor, allowing simultaneous access to data and memory with no wait states. The tightly coupled memory partition can still be accessed at ▶

CAN FD use cases

Faster software downloads: CAN FD speeds up the end-of-line programming of vehicles' ECUs. General Motors states that, with the use of CAN FD, the ECU programming time is only one-third or even one-fifth of the current programming time [1]. Likewise, diagnostics and software upgrades in repair garages are also faster.

Error status: A transmit-node error may result in a sudden stop of the message, thus affecting safety-critical systems. Every CAN FD message includes the condition of the transmit node in the error-status-information (ESI) bit. In this way, the receiver can monitor the transmit node and take fail-safe actions before any issues occur.

Increased data payload: CAN FD allows messages as long as 64 bytes to avoid splitting long messages. This feature results in a simplified transport layer of the CAN stack and requires no implementation of complex flow-control mechanisms involving multiple messages.

Faster communication between ECUs: The increasing amount of automotive features leads to an increase in data exchange among the automotive ECUs. With its higher bandwidth, CAN FD can handle the higher amount of data and it enables speeds similar to those of Flexray.

Reduced bus loads: As a result of the higher communication speed, the ECUs can send and receive data more quickly using CAN FD frames rather than the Classical CAN frames. This feature directly reduces bus loading. For example, an instrument cluster can inform a driver of many vehicle parameters. It drives three to seven gauges, controls 20 to 30 telltale devices, generates chimes, and displays signal warnings to indicate status or system malfunction. This node receives and transmits information via many CAN messages from multiple ECUs. Because CAN is a priority-based protocol, it delays lower priority messages and increases bus loading. These issues result in a reduced response time and the CAN load on such a system can be 75 % to 80 %. CAN FD alleviates this problem by reducing the load by more than 75 %.

Transmission-line length: Networks in trucks or articulated buses can be as long as 9 m to 20 m. The arbitration field limits the speed of the entire network. The J1939-14 standard defines a maximum bit-rate of 500 kbit/s. However, CAN FD enables much higher speeds. The arbitration fields may remain at 500 kbit/s, whereas the data payloads can be at much higher data rates, thus increasing the throughput of the network.

POSITAL

FRABA

SENSORS FOR MOBILE MACHINES



Absolute Rotary Encoders and Inclinometers

Reliable Measurement under Harsh Conditions

High Protection Class: IP69K

Fieldbus and Analog Interfaces

Safety, Redundant and ATEX
Ex-Proof Versions Available

Successfully Integrated in
Concrete Pumps, Drilling Machines,
Working Platforms, Cranes, Wheel Loaders,
Leader Masts and More

Choose from over 1 Million Sensors

PRODUCT
FINDER

The Easiest Way to Find the Product you Need!

www.posital.com

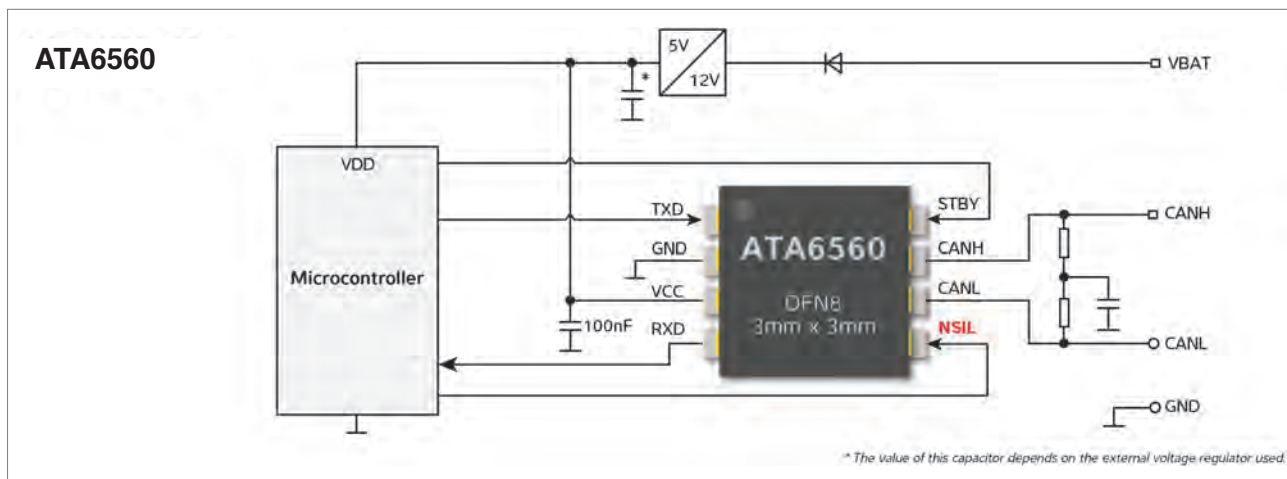

Figure 2: Typical application circuit of the ATA6560 (Photo: Microchip)

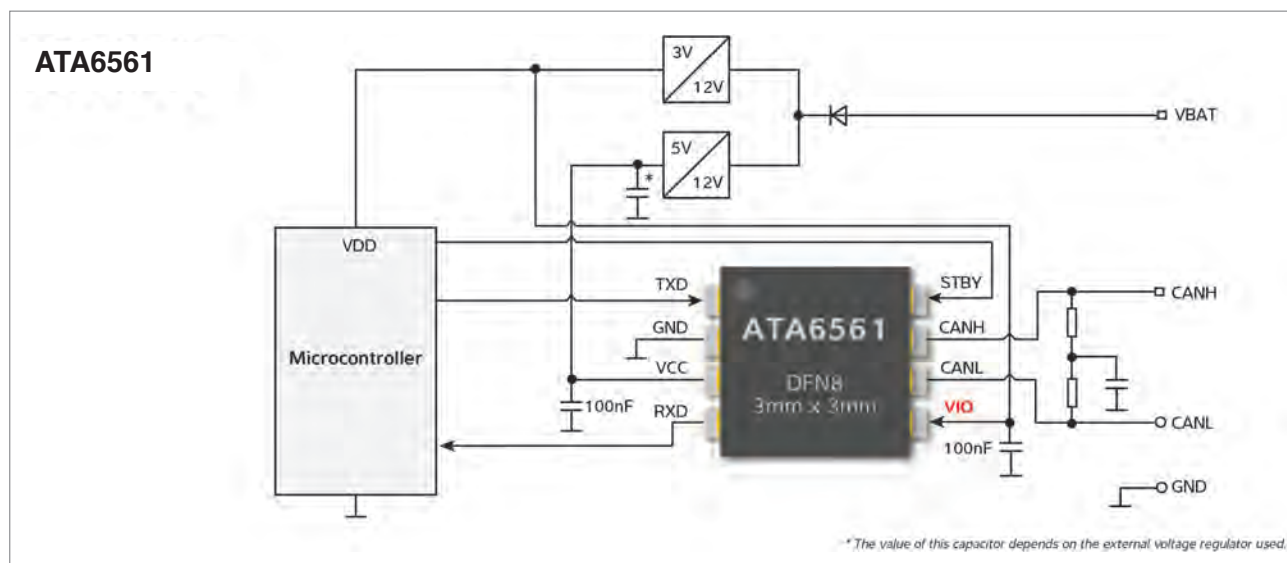

Figure 3: Typical application circuit of the ATA6561 (Photo: Microchip)

Features of CAN FD

The FDF (FD format) bit distinguishes between a CAN FD frame and a Classical CAN frame. The Classical CAN frame format is dominant, and the CAN FD frame format is recessive. Dominant means, “do not switch to a higher bit-rate—that is, maintain the same bit rate in the arbitration and the data phases,” and recessive means, “switch to a higher bit-rate.” With the ESI bit, dominant is the error-active node. The BRS (bit-rate-switch) bit allows the CAN FD rate to immediately start at the sampling point of the BRS. A recessive error indicates the passive node.

The res (reserved) bit follows the FDF bit and is reserved for future protocol expansions. In this field, dominant is the standard value. In this field, an FD-enabled receiver detects a protocol-exception event, during which it detects the res bit as recessive instead of the expected dominant value. A modified CRC (cyclic redundancy check) maintains the same hamming distance for the longer frames as Classical CAN frames. For CAN FD frames, the CRC field also contains the bit-stuff count.

lower priority through the multi-layer bus matrix. The no-wait-state nature of the tightly coupled memory makes it ideal for functions that must operate on data at a high frequency and with tight latency requirements – for example, digital signal processing functions operating on audio or video streams. Applications with a high percentage of such high-frequency time-critical operations would configure the available SRAM with more tightly couple memory (and therefore less system memory) compared to applications that have fewer of these types of operations.

Clocking options: All automotive ARM core devices include multiple clock options, ranging from external crystals to high frequency internal RC oscillators with high accuracy to low power internal RC oscillators. For the real time clock and calendar there is a dedicated 32-KHz low-power crystal oscillator. Phase or frequency locked loops are included to multiply the selected clock source to the needed operating frequency. And finally, the clock source to each peripheral can be individually gated. The combination of all these features allows the device to be configured to meet the performance-power consumption trade-off required by the application.

CAN FD provides an increased throughput at costs comparable to those of currently available CAN networks, ▶

as well as additional bandwidth and higher speeds. For automotive applications, CAN FD targets an average data rate of 2 Mbit/s with currently available CAN transceivers, resulting in the ability to carry the same effective payload as a low-speed Flexray network. At the same time, CAN FD maintains the reliability of Classical CAN due to changed CRC polynomials.

ATA6560 and ATA6561 CAN FD transceivers suit the CAN FD world and Classical CAN applications. The devices provide an easy migration path from Classical CAN systems to CAN FD systems because there is no need to change CAN application software, except for configuration software. The ARM Cortex-M7 core based SAMV7x microcontrollers combine industry standard 32-bit ARM M7 core processing performance along with innovative peripherals, including CAN FD, and system architecture features to create products that meet the challenging real-time performance demands of automotive applications. ◀

Industrial Ethernet Gateways / Bridges

**CAN / CANopen
EtherCAT
PROFINET**



CANopen

PROFINET

EtherCAT

CAN-EtherCAT

- Gateway between CAN/CANopen and EtherCAT
- Additional Ethernet interface for EoE

CANopen-PN

- Gateway between PROFINET-IO and CANopen
- PROFINET-IRT capable
- Simple configuration via S7 manager or TIA portal

ECX-EC

- EtherCAT slave bridge
- Process data exchange between two independent EtherCAT networks
- DC synchronization between EtherCAT masters

www.esd.eu

Authors

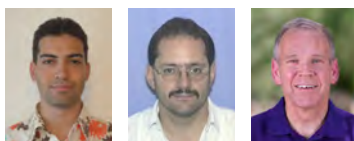

Daniel Yordanov
Berthold Gruber
Tim Grai
Microchip Technology
info@microchip.com
www.microchip.com



esd gmbh
Vahrenwalder Str. 207
30165 Hannover
Germany
Tel.: +49-511-3 72 98-0
info@esd.eu
www.esd.eu

US office:
esd electronics, Inc.
70 Federal Street - Suite #2
Greenfield, MA 01301
Phone: 413-772-3170
us-sales@esd-electronics.com
www.esd-electronics.us

Extra safety, comfort, and efficiency

Information that is made available by intelligent sensor systems increases the safety of mobile cranes and their efficiency. The information can be made available to the control system and the load torque limiter, and also to the crane operator.

Whether in mobile cranes, vehicle-, or truck-mounted cranes, intelligent sensors are nowadays indispensable for this entire range of cranes. Accurate detection of the support jack, the angle of the slewing ring, the angle of the overall vehicle, the installation angle of the booms, and the exact position of the winch are becoming an integral part of intelligent mobile cranes. But these systems are not only used to meet the requirements of EN ISO 13849 or EN 13000 to comply with the safety directives and therefore ensure the vehicle's stability. For some time, these sensors have also been used to increase the efficiency and performance of mobile cranes in commercial vehicles. During many years of experience in this area, Siko has developed a complete system of sensor components for exactly these types of vehicles in order to not only make cranes safer for use, but also to maximize the efficiency and performance of each crane. With sensors designed specifically for use in cranes, crane manufacturers have the option of intelligently networking their crane in order to increase performance. How this is achieved will be shown in the following example.

Wire-actuated encoders

The working environment at construction sites is often imperfect and confined. In many cases, the outrigger of mobile cranes cannot be fully extended and the crane is thereby limited in its use. Sometimes mobile cranes must be placed at the site in a way that limits the support width to only 60 %. In this case of limited installation space, a crane without active support monitoring only allows the crane to be supported at half the support length on both sides, for example. Thus, a large range of its actual performance spectrum is lost. In order to prevent exactly this type of loss, it is important to be able to precisely detect the position of each support jack at all times. Siko relies on wire-actuated encoders with a high degree of robustness. Using draw-wire sensors in the support jacks allows for the position of every jack to be continuously monitored and forwarded to the machine control system. This information enables the system to extend each support jack of the crane to the maximum possible reach allowed by the location, which means the outrigger can be variably extended. For example, outrigger can be fully retracted on one side of the crane while being fully extended on the other side. Comparing an old crane to a new crane with only half the support base, thanks to the sensors from Siko it is possible to achieve a significantly better reach into the desired



Figure 1: Siko sensors are used for rotary, linear, and angular measurement in a fire truck (Photo: Siko)

direction before the load torque limitation switches off the crane's movement.

For this application, Siko has been continuously developing draw-wire sensors over the last 30 years hand-in-hand with its customers, in order to meet the demands of the harsh environment of mobile cranes and to achieve an increase in performance. Furthermore, the durable structure of the sensors is even more impressive, especially for mobile applications. For example, the spring assembly is protected against the ingress of dirt and water and always works perfectly even at temperatures below freezing.

Redundant length measuring systems for functional safety

In recent years, increasingly safe wire-actuated encoders have been developed based on changing standards. The safety assessment has increased considerably especially for mobile cranes, not just since the new draft of EN 13000. The wire-actuated encoders SG32, SG42, and SG62 offer this improved safety by means of a special and complete redundant sensor technology, which measures the absolute position. Two completely separate sensor ▶



Figure 2: Redundant wire-actuated encoders SG32 and SG42 (Photo: Siko)

systems detect the exact position and display them separately as analog signals. With measuring lengths between 3 m and 6 m, these sensors are suited to determine the position of outriggers on cranes and working platforms as well as for determining the position of booms. In combination with safe control systems, the wire-actuated encoders allow the overall system to be certified pursuant to SIL2/PLd. With MTBF (mean time between failures) values of >100 years, these sensors are suited for use in certified complete systems.

To use digital interfaces, products with CANopen (with a simple or redundant design), J1939, or CANopen Safety interfaces are available. This gives the customer the option to choose from a variety of wire-draw mechanisms. Diverse sizes are available with lengths between 1 m and 15 m. Thanks to the flexible attachment system, the wire-actuated encoders can be factory-fitted with the desired fieldbus interface.

Accurate detection of slewing ring position

Another important point in the overall system is the deflection of the crane. The position of the slewing ring is a vital factor for the load moment limit, which must be taken into account to calculate the tilting line, in addition to the correct jacking width. In order to detect the position of the slewing ring continuously and safely, it is important to use an absolute encoder. During the development of the rotary encoder from Siko, which was designed specifically for this application, special attention was given to the encoder's adaptation to the slewing ring. Thus, the shaft load capacity of these encoders has been increased. Furthermore, optional form-fitting and spring-loaded external gears are mounted for use on slewing rings. These serve to compensate for the backlash of the slewing ring to the external gear, thus always providing accurate position sensing.

Another important point is the conversion of the absolute position of the rotary encoder in relation to the real position of the slewing ring. Because the encoder is connected to the slewing ring via an external gear and the transmission ratio is usually an uneven or odd number of transmissions, the conversion to a 0° to 360° value is not always easy for the machine manufacturer because the position of the slewing ring should always be resolved in 360°, no matter how often the slewing ring turns in one direction and even if the rotary encoder exceeds its internal zero point after 4096 revolutions. Siko has implemented a special software in the WV58MR rotary encoder for this ▶



Visualize
with safety!

STW

interACT-VSX-Series Display Family

- Variants from 7 to 15 inches
- SIL2-qualified hardware and software platform
- Extendable through expansion boards
- High viewing angle
- Graphical design and programming tool

Exhibition Dates



bauma China, Shanghai (CHN)
22.11. – 25.11.2016



SPS/IPC/DRIVES, Nuremberg
22.11. – 24.11.2016
Hall 7, Booth 150



bauma conexpo India,
Gurgaon, Delhi (IND)
12.12. – 15.12.2016





Figure 3: Safety concepts for mobile machines with wire-actuated encoder SG32, the redundant encoder WV58MR, and the inclinometer IK360 (Photo: Siko)

purpose, which relieves the programmer of the machine of this problem. This software allows users to configure the number of teeth of the slewing ring and the number of teeth of the external gear in the rotary encoder, which enables the generation of virtually any transmission. Thus, the rotary encoder outputs the exact position of the slewing ring via the interface as well as its speed and relieves the machine manufacturer from having to recalculate the position. This solution does not only provide a simplification for implementation, but the encoder is also easy to implement into vastly different machines. No matter how big the slewing ring, the same encoder system can be used in all cases. The machine manufacturer can thus reduce the number of variants, resulting in fewer individual parts and fewer encoders being necessary.

Another important aspect is selecting the right interface. In order to ensure the customer has maximum flexibility in this regard, the slewing ring encoders are available with all standard interfaces. Depending on the application, the customer can choose between analog outputs, CANopen, or J1939 interfaces. A redundant version of the slewing ring encoder is available with a redundant CANopen interface or CANopen Safety.

Away from the sun

A further important factor to realize the optimum performance range of the crane is provided by an additional encoder of the sensor system for mobile cranes. As soon as the telescopic boom is extended skywards, the load torque limiter must detect the exact installation angle of the boom. For this too, the single-turn version of the redundant rotary encoder WV58MR is used on the swivel joints of the telescope. Robust and resistant to environmental influences, it withstands harsh weather conditions. With protection class IP67, a wide temperature range of -40 °C to +85 °C, and a special protective coating, it is suited for mobile machines. By simple adaptation of the rotary encoder, it can detect the exact installation angle directly on the boom and forward this information via the interface.

The cable drum in the boom system is also taken into account. So-called winch-encoders ensure safety and feed the control system and safety system of the drum with information. The winch encoder is directly, positively coupled with the suspension rope drum and records the length of the suspension rope as well as its direction and speed. The rotary encoder permanently monitors the function of the suspension rope drum through the position and

speed limit values, which can be configured internally. If the speed limit is exceeded or a limit position is violated, the two internal sensor systems report this automatically through emergency messages via bus signals to the controller or the safety system of the suspension rope drum.

Always on a firm footing

In order to always ensure a firm footing, it is important to know (in addition to the angle and path) whether or not the vehicle inclination even permits the load under the relevant conditions. In order to properly detect the angle of the vehicle to the ground, Siko takes advantage of a simple natural feature: gravity.

The sensor uses gravity to detect positions with a system accuracy of $\pm 0,1^\circ$ in the range up to 360° . The microelectromechanical measuring systems (MEMS) within the sensor detect the precise orientation of the vehicle to the ground. An IK360 inclinometer as a single-axis version (0° to 360°) or as a two-axle version ($\pm 80^\circ$) is available for this. The IK360 is also characterized by quick, uncomplicated, and error-free installation through three-point mounting. In addition, the small tilt sensor impresses with its protection class IP69K. This means the fully encapsulated sensor can also be mounted in the undercarriage and can deal with water and dirt in any situation.

Performance increase in the system

Through the examples described above, it becomes clear that information that is made available by intelligent sensor systems not only increases the safety of mobile cranes, but also their efficiency and performance. Through this, permissible workloads can be calculated directly in the crane control system and continuously updated in real-time during crane movements. Linking these values helps to calculate the tilting edge, the current center of gravity of the crane with load. But the control system and the safety-related load torque limiter are not the only ones to profit from this. The collected information can be made available to the crane operator, which can make his work much easier in and on the crane. Accidents caused by incorrect operation can be avoided both during setup and when lifting loads. Through this new flexibility, dispatchers can better plan the deployment of their vehicles to construction sites and thus use the vehicles more efficiently. Consequently, the end user benefits directly, not only through improved safety, but also through a higher load capacity and a larger work area when using the crane. ◀



Author

Mathias Roth
Siko
mathias.roth@siko.de
www.siko.de



Hardware & Software for CAN Applications

■ PCAN-Explorer 6

Professional Windows® Software to Communicate with CAN and CAN FD Busses

The PCAN-Explorer is a versatile, professional Windows® software for the observation, control, and simulation of CAN busses. Besides CAN 2.0 A/B, the PCAN-Explorer 6 now also supports the CAN FD standard with up to 64 data bytes per CAN message.

Features

- Simultaneous connections with multiple CAN interfaces independent of their hardware type
- Support for the CAN specifications 2.0 A/B and FD
- Transmission of CAN FD data with bit rates up to 12 Mbit/s
- Clear display of the CAN traffic with various information
- Configurable symbolic message representation
- Easy manual and periodic message transmission
- Data logging with tracers and the 4-channel Line Writer
- Playback of trace files with optional loop function
- Multiple flexible filters, also usable for recorded trace files
- Automation of small tasks or complex processes with macros or VBScript
- Management of settings, information, and files in projects
- Export of entire projects including linked files to handy packets for archiving or sharing

Optional functionality upgrades:

- Plotter Add-in: Recording and graphical representation of multiple signal sequences
- Instruments Panel Add-in: Representation of digital and analog signals via graphical instruments for easy simulation of complex CAN applications
- J1939 Add-in: Support for functions of the SAE J1939 network protocol
- CANdb Import Add-in: Direct use and optional import of CANdb files

System requirements

- Windows® 10, 8.1, 7 (32/64-bit)
- At least 2 GB RAM and 1.5 GHz CPU
- For the CAN bus connection: PC CAN interface from PEAK-System
- Free USB port for copy protection dongle (only for portable license)

Training:

We offer training sessions for the PCAN-Explorer and CAN basics for groups or individuals. If you are interested, please contact training@peak-system.com.



www.peak-system.com

Take a look at our website for the international sales partners. Scan the QR code on the left to open that page.

PEAK-System Technik GmbH

Otto-Roehm-Str. 69, 64293 Darmstadt, Germany
Phone: +49 6151 8173-20 - Fax: +49 6151 8173-29
E-mail: info@peak-system.com





CAN in Automation

16th international CAN Conference (iCC)

Historical City Hall, Nuremberg (DE), March 7 - 8, 2017

Call for papers

CiA, the international users' and manufacturers' group for CAN, will organize the 16th iCC in Nuremberg (DE), March 7 - 8, 2017 in conjunction with its 25 years anniversary.

Topics of the 16th international CAN Conference (the term CAN includes CAN FD and classical CAN):

- CAN implementations
- CAN device design
- CAN system design
- CAN diagnostic and tools
- CAN higher-layer protocols
- CAN-related research studies
- CAN applications in vehicles
- CAN applications in industry
- CAN in general purpose applications
- Other CAN applications

Please submit your abstract (not more than 200 words) before **September 16, 2016**. The conference language is English.

For more details, please, contact the CiA office at headquartes@can-cia.org

www.can-cia.org